

PREFACE

This Service Manual describes the technical features and servicing procedures for the **KYMCO AGILITY 125**

Section 1 contains the precautions for all operations stated in this manual. Read them carefully before starting any operation.

Section 2 is the removal/installation procedures for the frame covers which are subject to higher removal/installation frequency during maintenance and servicing operations.

Section 3 describes the inspection/adjustment procedures, safety rules and service information for each part, starting from periodic maintenance.

Sections 6 through 17 give instructions for disassembly, assembly and inspection of engine, chassis frame and electrical equipment.

Most sections start with an assembly or system illustration and troubleshooting for the section. The subsequent pages give detailed procedures for the section.

Our company reserves the right to make any alteration in the design.
The information and contents included in this manual may be different from the motorcycle in case specifications are changed.

KWANG YANG MOTOR CO., LTD.
OVERSEAS SALES DEPARTMENT
OVERSEAS SERVICE SECTION

TABLE OF CONTENTS

ENGINE	GENERAL INFORMATION	1
	FRAME COVERS/EXHAUST MUFFLER	2
	INSPECTION/ADJUSTMENT	3
	LUBRICATION SYSTEM	4
	FUEL SYSTEM	5
	ENGINE REMOVAL/INSTALLATION	6
	CYLINDER HEAD/VALVES	7
	CYLINDER/PISTON	8
	DRIVE AND DRIVEN PULLEYS/KICK STARTER	9
	FINAL REDUCTION	10
	CRANKCASE/CRANKSHAFT	11
CHASSIS	FRONT WHEEL/FRONT BRAKE/FRONT SUSPENSION	12
	REAR WHEEL /REAR BRAKE /REAR SUSPENSION	13
ELECTRICAL EQUIPMENT	BATTERY/CHARGING SYSTEM/A.C. GENERATOR	14
	IGNITION SYSTEM	15
	STARTING SYSTEM	16
	LIGHTS/INSTRUMENTS/SWITCHES	17
	EVAPORATIVE/EXHAUST EMISSION CONTROL SYSTEM	18

ENGINE SERIAL NUMBER	1- 1	LUBRICATION POINTS	1-13
SPECIFICATIONS	1- 2	CABLE & HARNESS ROUTING	1-15
SERVICE PRECAUTIONS	1- 3	WIRING DIAGRAM.....	1-20
TORQUE VALUES	1-11	TROUBLESHOOTUNG	1-21
SPECIAL TOOLS	1-12		

ENGINE SERIAL NUMBER



AGILITY 125 (Narrow cover front)

AGILITY 125 (Wide cover front)

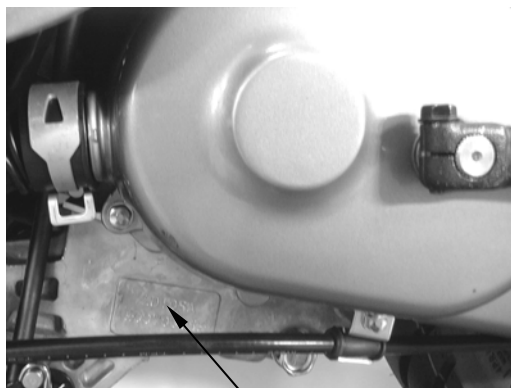

Location of Engine Serial Number

1. GENERAL INFORMATION

AGILITY 125

SPECIFICATIONS

Motorcycle Name & Type		AGILITY 125		
Name & Model No.		LDF7		
Overall length (mm)		1830		
Overall width (mm)		690		
Overall height (mm)		1125		
Wheel base (mm)		1315		
Engine type		O.H.C.		
Displacement		124.6cc		
Fuel Used		92# nonleaded gasoline		
Net weight (kg)	Front wheel	40		
	Rear wheel	66		
	Total	106		
Gross weight(kg)	Front wheel	40		
	Rear wheel	70		
	Total	110		
Tires	Front wheel	120/70 -12 56J		
	Rear wheel	130/70 -12 56J		
Ground clearance (mm)		127		
Performance	Braking distance (m)	7 (Initial speed 30km/h)		
	Min. turning radius (m)	1.99		
Engine	Starting system		Starting motor & kick starter	
	Type		Gasoline, 4-stroke	
	Cylinder arrangement		Single cylinder	
	Combustion chamber type		Semi-sphere	
	Valve arrangement		O.H.C.	
	Bore x stroke (mm)		φ52.4 x 57.8	
	Compression ratio		9.6±0.2	
	Compression pressure (kg/cm ² -rpm)		13±2	
	Max. output		6.9/7500kw/(r/min)	
	Max. torque		9.1/6500N.m/rpm	
	Port timing	Intake	Open	-2.5°
			Close	32°
		Exhaust	Open	-3°
			Close	33°
	Valve clearance (cold) (mm)	Intake	0.12	
		Exhaust	0.12	
	Idle speed (rpm)		1700±100rpm	
	Lubrication System	Lubrication type		Forced pressure & wet sump
		Oil pump type		Inner/outer rotor type
		Oil filter type		Full-flow filtration
Oil capacity		0.8 liter		
Cooling Type		Forced air cooling		
Fuel System	Air cleaner type & No		Paper element, wet	
	Fuel capacity		5 liter	
	Carburetor	Type	VE	
		Piston dia. (mm)	φ22	
Venturi dia.(mm)		φ26equivalent		
Throttle type		Butterfly type		
Electrical Equipment	Ignition System	Type	CDI	
		Ignition timing	BTDC27°±2° /4000rpm	
		Contact breaker	Non-contact point type	
		Spark plug	NGK CR7HSA CHAMPION P-RZ9 HC	
		Spark plug gap	0.6~0.7mm	
Battery	Capacity		12V8AH	
Power Drive System	Clutch	Type	Dry multi-disc clutch	
		Transmission Gear	Type	Non-stage transmission
	Reduction Gear		Operation	Automatic centrifugal type
		Type	Two-stage reduction	
Reduction ratio	1st	1.0-2.8		
	2nd	46/16*46/15		
Moving Device	Front Axle	Caster angle		27°
		Trail length		—
	Tire pressure (kg/cm ²)	Front	1.75	
		Rear	2.25	
Turning angle	Left	45°		
	Right	45°		
Brake system type		Front	DISK (180mm) brake	
		Rear	Drum (110mm) brake	
Damping Device	Suspension type	Front	TELESCOPE	
		Rear	Unit Swing	
	Shock absorber distance	Front	410.1±2.5mm	
		Rear	351.6±2mm	
Frame type		Steel Pipel		

1. GENERAL INFORMATION

SERVICE PRECAUTIONS

- Make sure to install new gaskets, O-rings, circlips, cotter pins, etc. when reassembling.

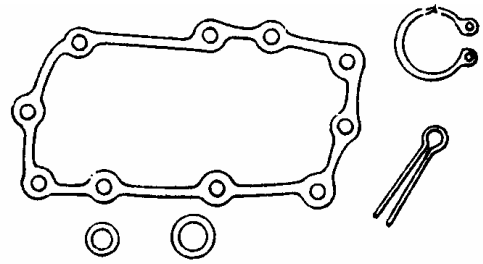

- When tightening bolts or nuts, begin with larger-diameter to smaller ones at several times, and tighten to the specified torque diagonally.

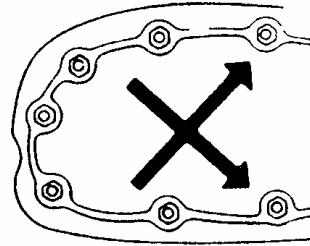

- Use genuine parts and lubricants

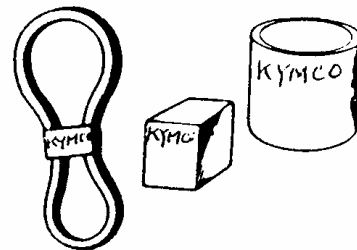

- When servicing the motorcycle, be sure to use special tools for removal and installation.

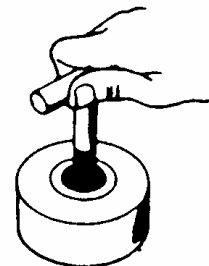

- After disassembly, clean removed parts. Lubricate sliding surfaces with engine oil before reassembly.

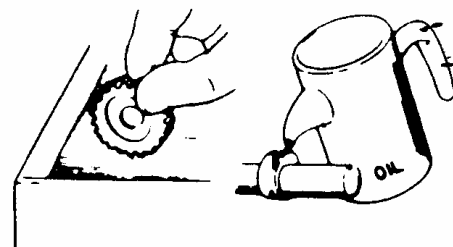

1. GENERAL INFORMATION

- Apply or add designated greases and lubricants to the specified lubrication points.

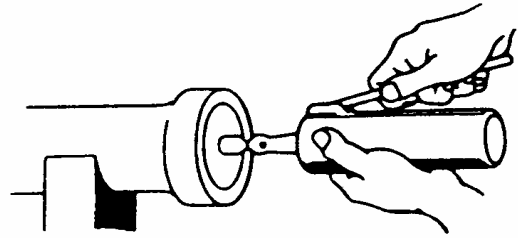

- After reassembly, check all parts for proper tightening and operation.

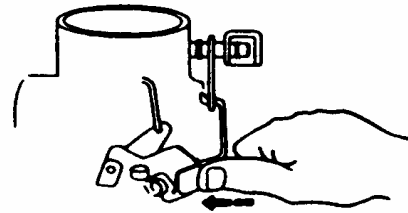

- When two persons work together, pay attention to the mutual working safety.

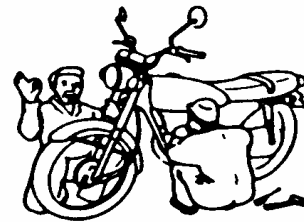

- Disconnect the battery negative (-) terminal before operation.
- When using a spanner or other tools, make sure not to damage the motorcycle surface.

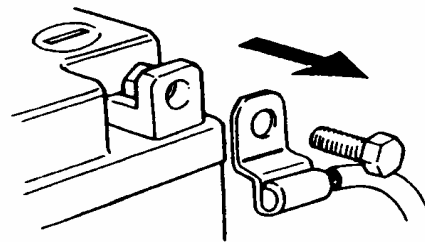

- After operation, check all connecting points, fasteners, and lines for proper connection and installation.
- When connecting the battery, the positive (+) terminal must be connected first.
- After connection, apply grease to the battery terminals.
- Terminal caps shall be installed securely.

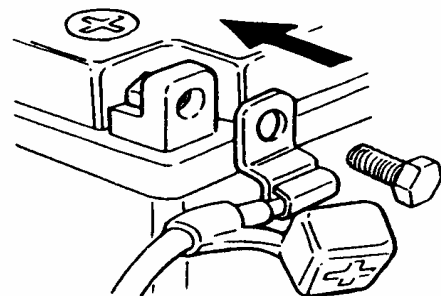

1. GENERAL INFORMATION

- If the fuse is burned out, find the cause and repair it. Replace it with a new one according to the specified capacity.

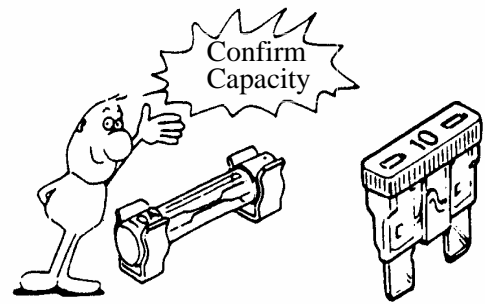

- After operation, terminal caps shall be installed securely.

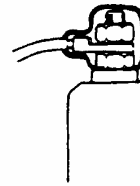

- When taking out the connector, the lock on the connector shall be released before operation.

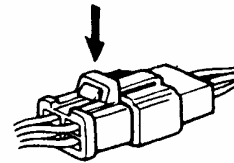

- Hold the connector body when connecting or disconnecting it.
- Do not pull the connector wire.



- Check if any connector terminal is bending, protruding or loose.

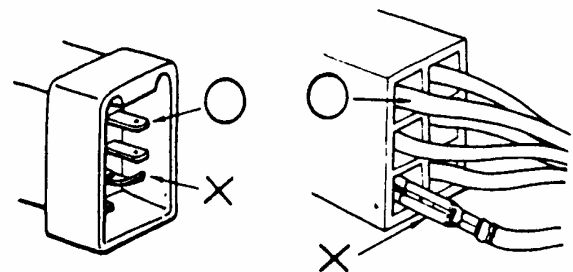

1. GENERAL INFORMATION

- The connector shall be inserted completely.
- If the double connector has a lock, lock it at the correct position.
- Check if there is any loose wire.

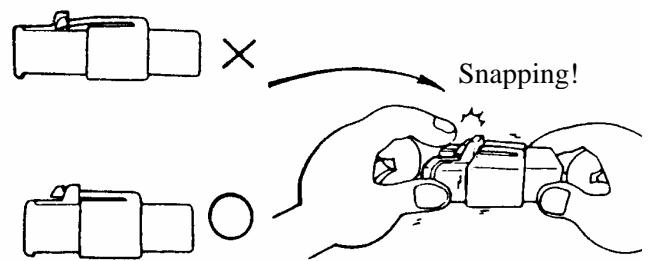

- Before connecting a terminal, check for damaged terminal cover or loose negative terminal.

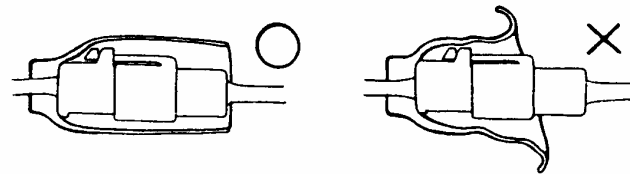

- Check the double connector cover for proper coverage and installation.

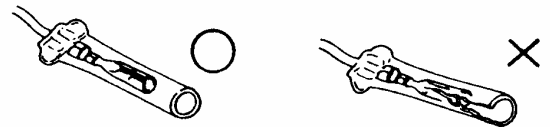

- Insert the terminal completely.
- Check the terminal cover for proper coverage.
- Do not make the terminal cover opening face up.

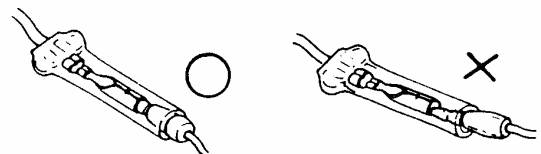

- Secure wire harnesses to the frame with their respective wire bands at the designated locations. Tighten the bands so that only the insulated surfaces contact the wire harnesses.

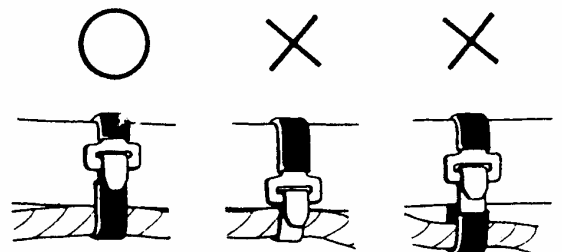

1. GENERAL INFORMATION

- After clamping, check each wire to make sure it is secure.

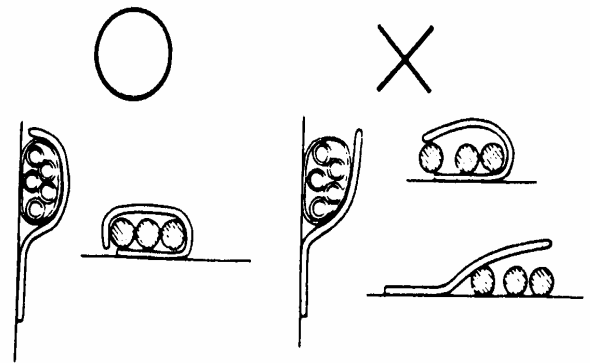

- Do not squeeze wires against the weld or its clamp



- After clamping, check each harness to make sure that it is not interfering with any moving or sliding parts.

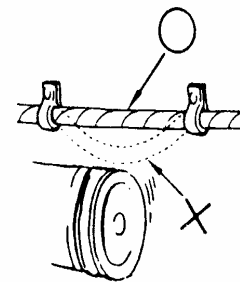

- When fixing the wire harnesses, do not make it contact the parts which will generate high heat.

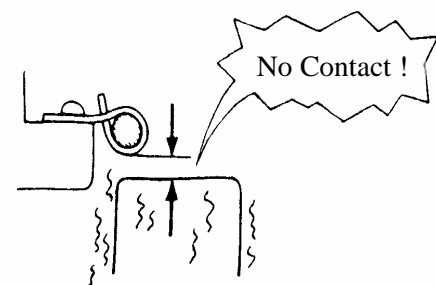

- Route wire harnesses to avoid sharp edges or corners. Avoid the projected ends of bolts and screws.
- Route wire harnesses passing through the side of bolts and screws. Avoid the projected ends of bolts and screws.

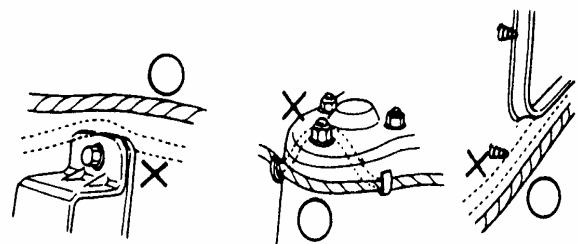

1. GENERAL INFORMATION

- Route harnesses so they are neither pulled tight nor have excessive slack.

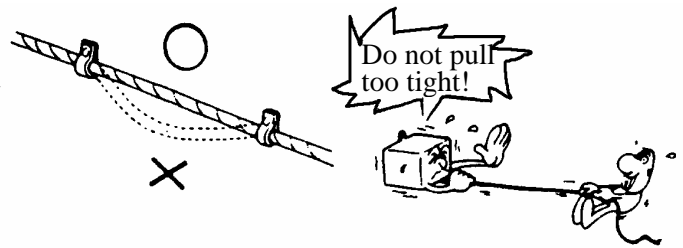

- Protect wires and harnesses with electrical tape or tube if they contact a sharp edge or corner

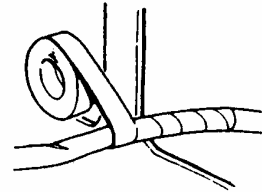

- When rubber protecting cover is used to protect the wire harnesses, it shall be installed securely.

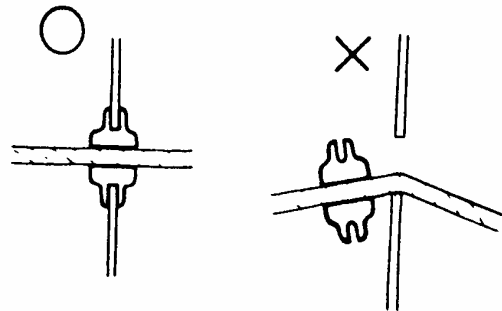

- Do not break the sheath of wire.
- If a wire or harness is with a broken sheath, repair by wrapping it with protective tape or replace it.

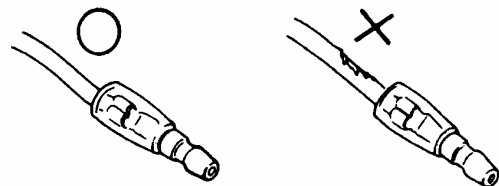

- When installing other parts, do not press or squeeze the wires.



1. GENERAL INFORMATION

- After routing, check that the wire harnesses are not twisted or kinked.

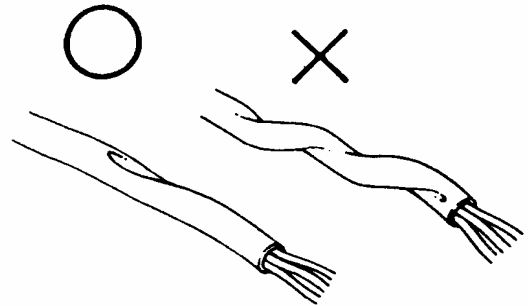

- Wire harnesses routed along with handlebar should not be pulled tight, have excessive slack or interfere with adjacent or surrounding parts in all steering positions.

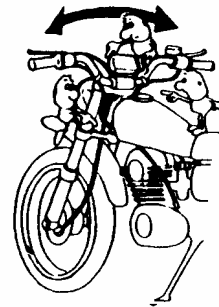

- When a testing device is used, make sure to understand the operating methods thoroughly and operate according to the operating instructions.

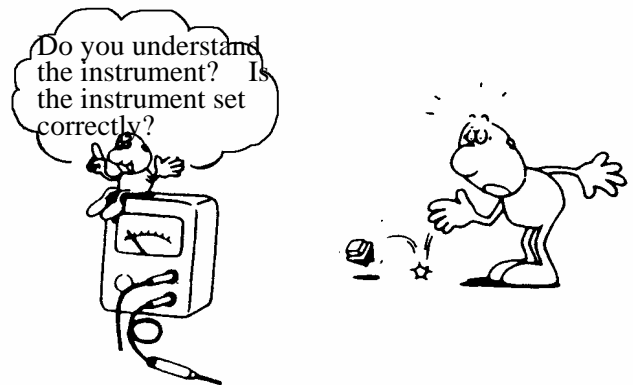

- Be careful not to drop any parts.

- When rust is found on a terminal, remove the rust with sand paper or equivalent before connecting.

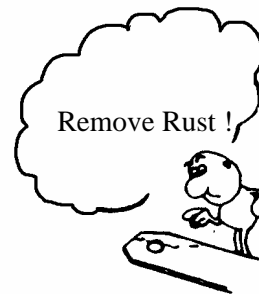

- Do not bend or twist control cables. Damaged control cables will not operate smoothly and may stick or bind.

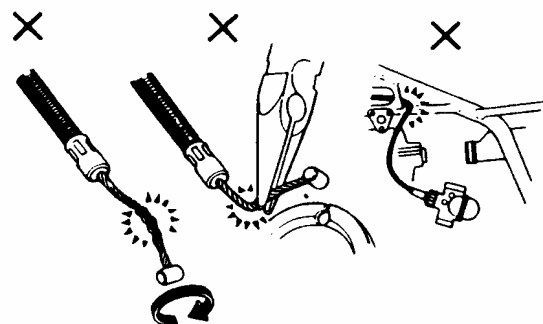

1. GENERAL INFORMATION

■ Symbols:

The following symbols represent the servicing methods and cautions included in this service manual.



Engine Oil

: Apply engine oil to the specified points. (Use designated engine oil for lubrication.)



Grease

: Apply grease for lubrication.



Gear Oil

: Transmission Gear Oil (90#)



: Use special tool.



: Caution



: Warning

(⇒12-3) : Refer to page 12-3.

1. GENERAL INFORMATION

TORQUE VALUES

STANDARD TORQUE VALUES

Item	Torque (kg-m)	Item	Torque (kg-m)
5mm bolt, nut	0.45-0.6	5mm screw	0.35-0.5
6mm bolt, nut	0.6-1.2	6mm screw, SH bolt	0.7-1.1
8mm bolt, nut	1.8-2.5	6mm flange bolt, nut	1.0-1.4
10mm bolt, nut	3.0-4.0	8mm flange bolt, nut	2.4-3.0
12mm bolt, nut	5.0-6.0	10mm flange bolt, nut	3.5-4.5

Torque specifications listed below are for important fasteners.

ENGINE

Item	Q'ty	Thread dia.(mm)	Torque (kg-m)	Remarks
Cylinder head bolt A	2	6	0.7-1.1	Double end bolt
Cylinder head bolt B	4	6	0.7-1.1	
Oil filter screen cap	1	30	1.0-2.0	Double end bolt Apply oil to threads
Exhaust muffler lock bolt	2	6	0.7-1.1	
Cylinder head flange nut	4	7	1.2-1.6	
Valve adjusting lock nut	2	3	0.07-0.09	
Cam chain tensioner slipper bolt	1	8	0.4-0.7	
Oil bolt	1	8	1.1-1.5	
Clutch outer nut	1	10	3.5-4.5	
Clutch drive plate nut	1	28	5.0-6.0	
Starter motor mounting bolt	2	6	0.8-1.2	
Oil pump bolt	3	4	0.1-0.3	
Drive face nut	1	10	5.5-6.5	
Spark plug	1	10	1.0-1.4	
A.C. generator stator bolt	2	6	0.8-1.2	
Cam chain tensioner bolt	1	6	0.8-1.2	

FRAME

Item	Q'ty	Thread dia.(mm)	Torque (kg-m)	Remarks
Steering stem lock nut	1	25.4	8.0-12.0	U-nut
Front axle nut	1	10	5.0-7.0	U-nut
Rear axle nut	1	14	11.0-13.0	U-nut
Rear shock absorber upper bolt	1	10	4.0-5.0	Apply locking agent
Rear shock absorber lower bolt	1	8	2.0-3.0	
Speedometer cable set screw	1	5	0.45-0.6	
Rear shock absorber lock nut	1	8	3.0-3.6	

SPECIAL TOOLS

Tool Name	Tool No.	Remarks	Ref. Page
Bearing puller 10.12.15.18 mm	E037	10.12.15.18mm bearing	10-3 10-4 12-6
Bushing remover L	E032	11102 bush engine hanger rubber	
Bushing remover S	EO19	11203 bush rear cushion under rubber	
Crankshaft bearing puller	E030	91005 radial bearing	
Crankshaft protector	E029	13000 crankshaft comp 12mm.14mm	
Clutch spring compressor	E027	2301a driven pully assy	9-9 9-12
Cushion assemble & disassemble tool	F004	52400 cushion assy	13-4
Flywheel holder	E017	31110 flywheel comp.2310a pully assy driven	9-5 9-9 9-13 14-7 14-9
Flywheel puller	E002	Left hand thread 27mm	14-7
Long socket wrench 32mm 8angle	F002	50306 steering stem	12-21 12-22
Oil seal & bearing installer	E014	Oil seal & bearing install	
Tool boox	E033	Special tools storage	
Tappet adjuster	E036	90012 screw tappet	3-5
Valve spring compressor	E038	Valve spring	7-7 7-8

1. GENERAL INFORMATION

LUBRICATION POINTS

ENGINE

Lubrication Points	Lubricant
Valve guide/valve stem movable part Cam lobes Valve rocker arm friction surface Cam chain Cylinder lock bolt and nut Piston surroundings and piston ring grooves Piston pin surroundings Cylinder inside wall Connecting rod/piston pin hole Connecting rod big end Crankshaft R/L side oil seal Starter reduction gear engaging part Countershaft gear engaging part Final gear engaging part Bearing movable part O-ring face Oil seal lip	<ul style="list-style-type: none"> •Genuine KYMCO Engine Oil (SAE15W-40) •API-SG Engine Oil
Starter idle gear Friction spring movable part/shaft movable part Shaft movable grooved part Kick starter spindle movable part	High-temperature resistant grease
A.C. generator connector Transmission case breather tube	Adhesive

1. GENERAL INFORMATION

FRAME

The following is the lubrication points for the frame.

Use general purpose grease for parts not listed.

Apply clean engine oil or grease to cables and movable parts not specified.

This will avoid abnormal noise and rise the durability of the motorcycle.



1. GENERAL INFORMATION

CABLE & HARNESS ROUTING

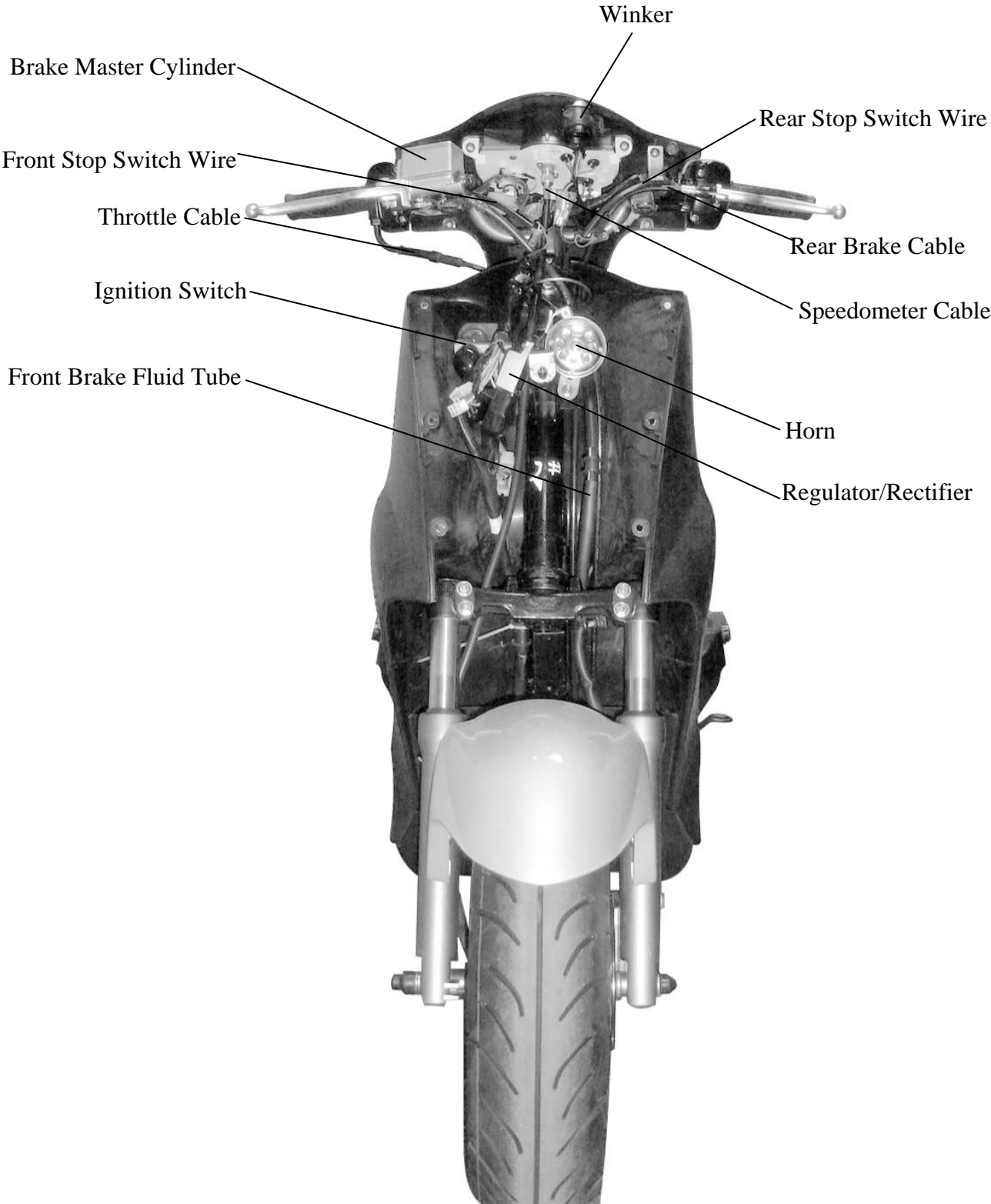

1. GENERAL INFORMATION

AGILITY 125

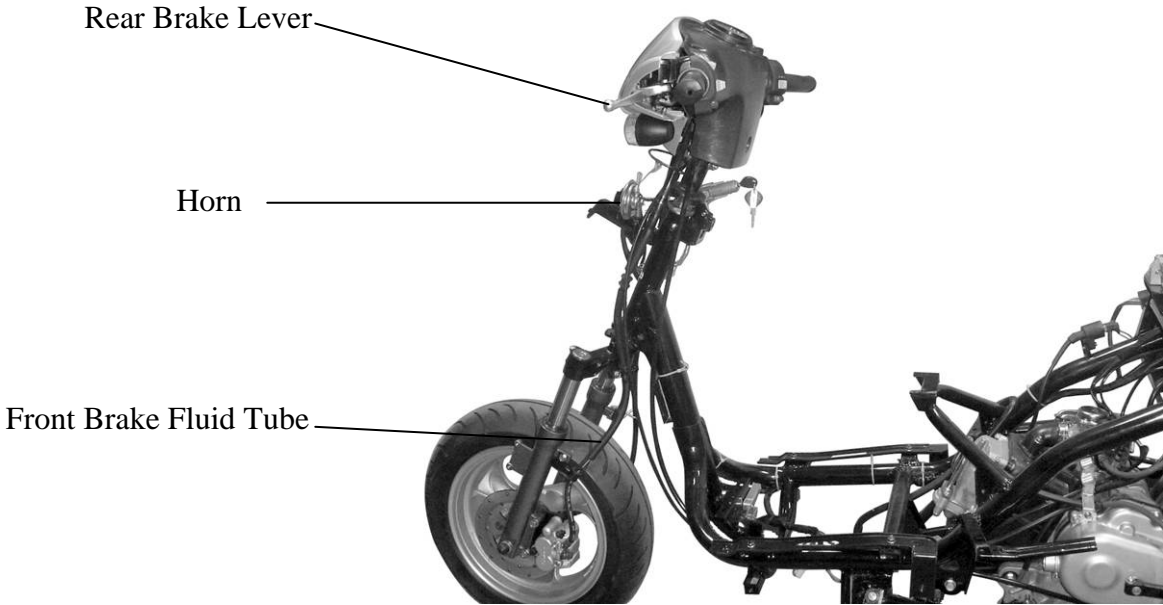
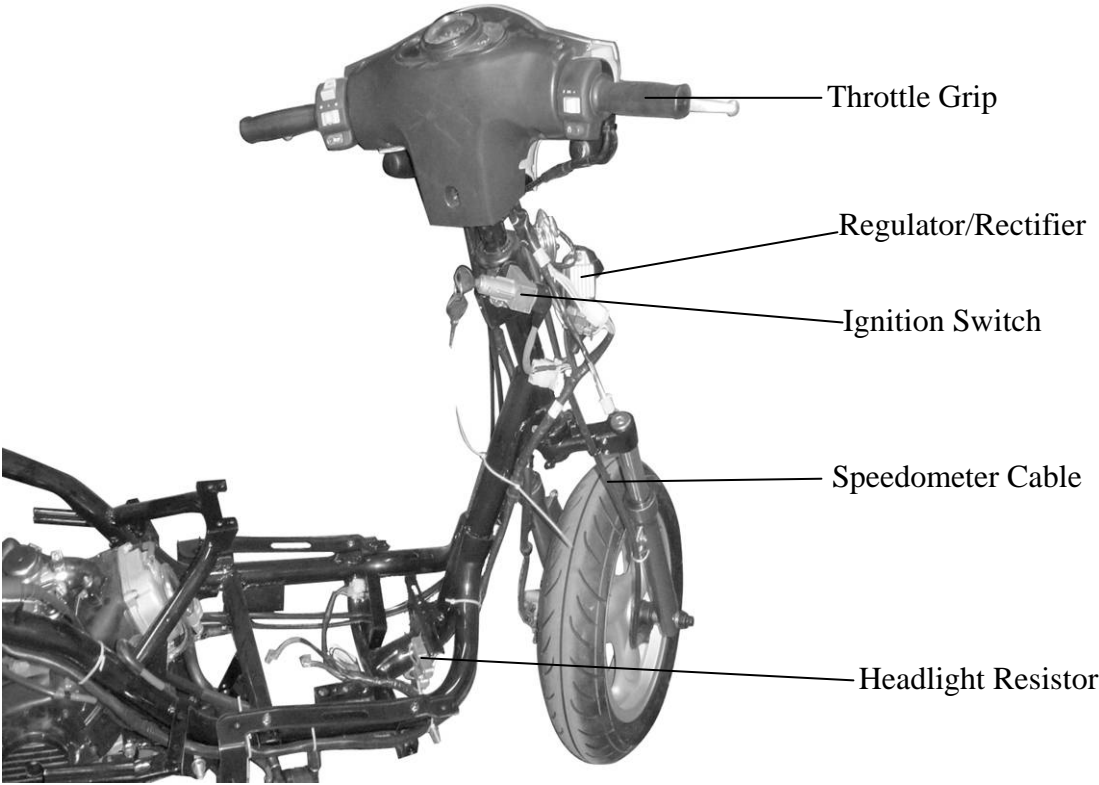

1. GENERAL INFORMATION

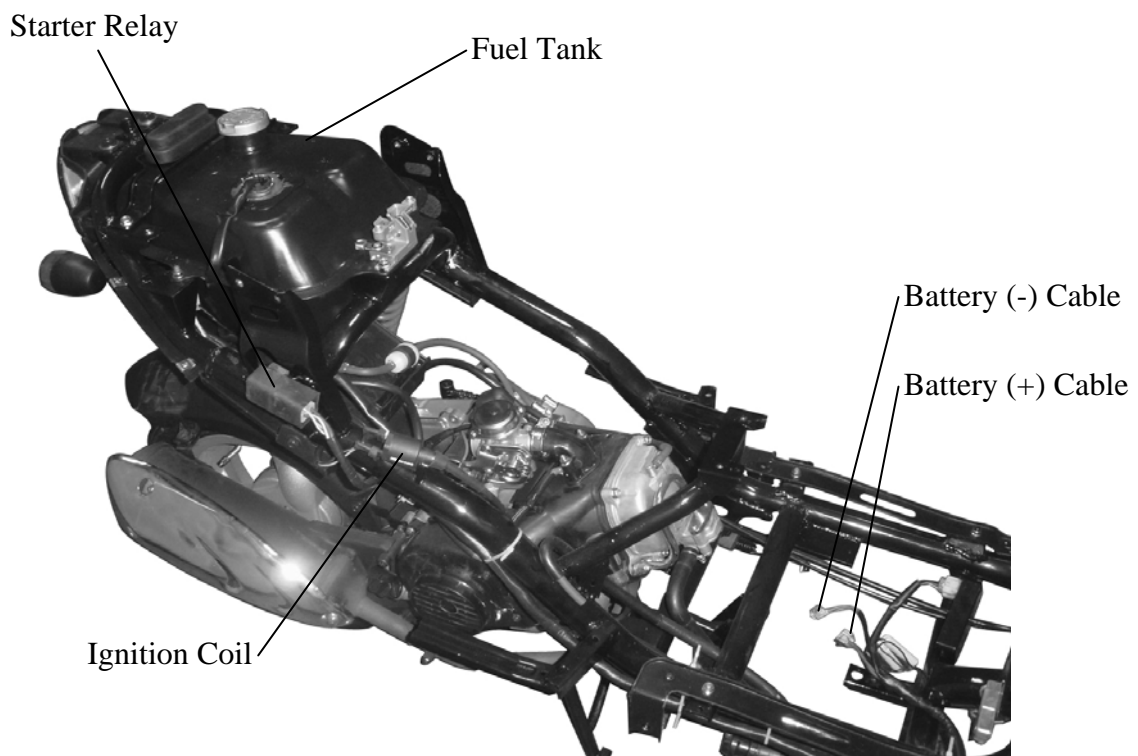
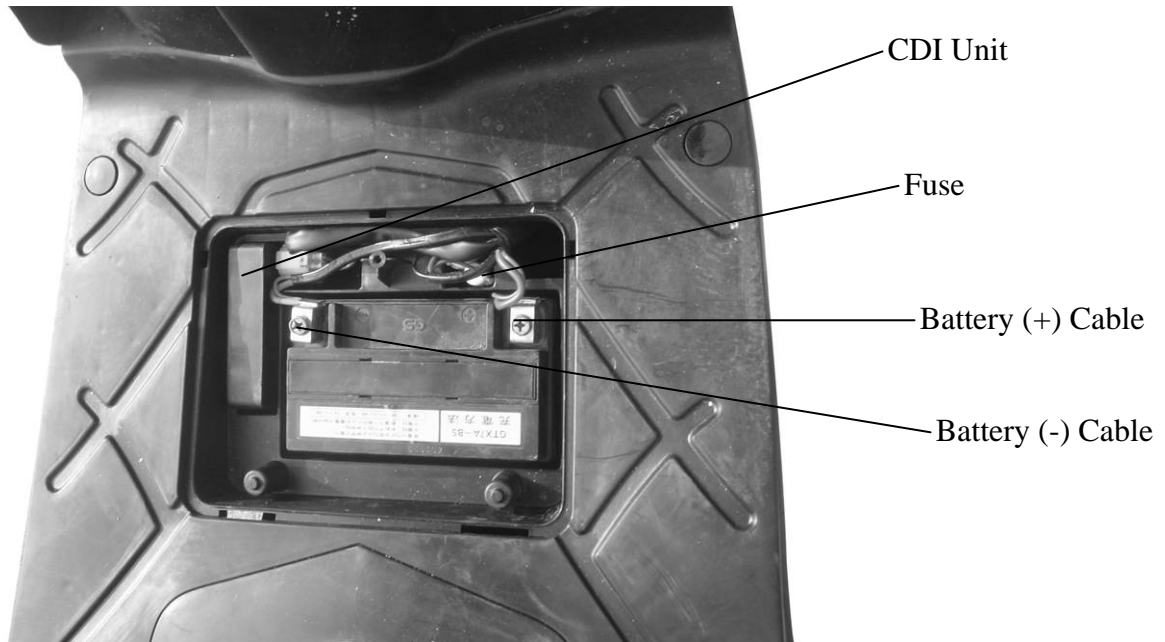

1. GENERAL INFORMATION

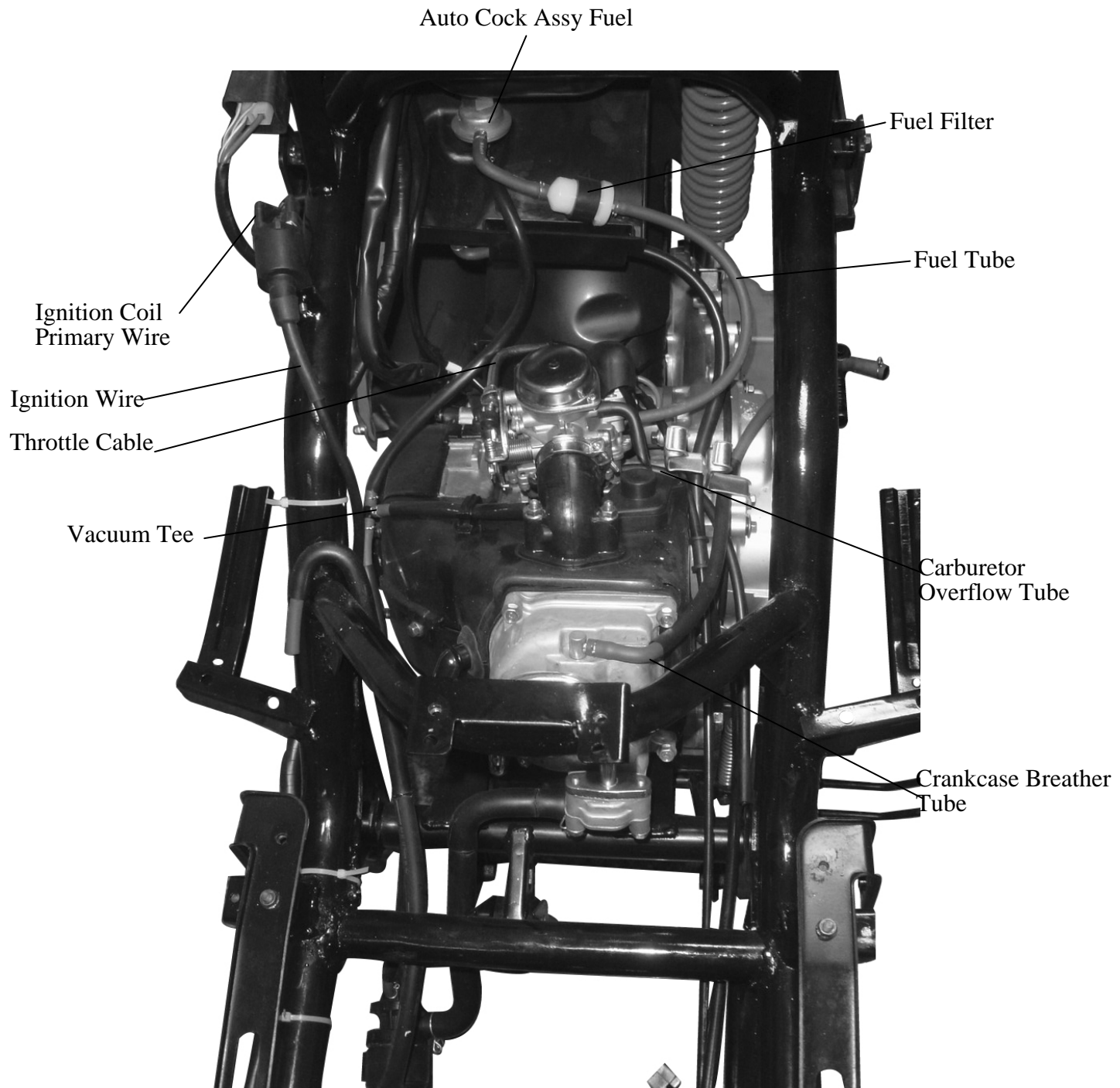

1. GENERAL INFORMATION

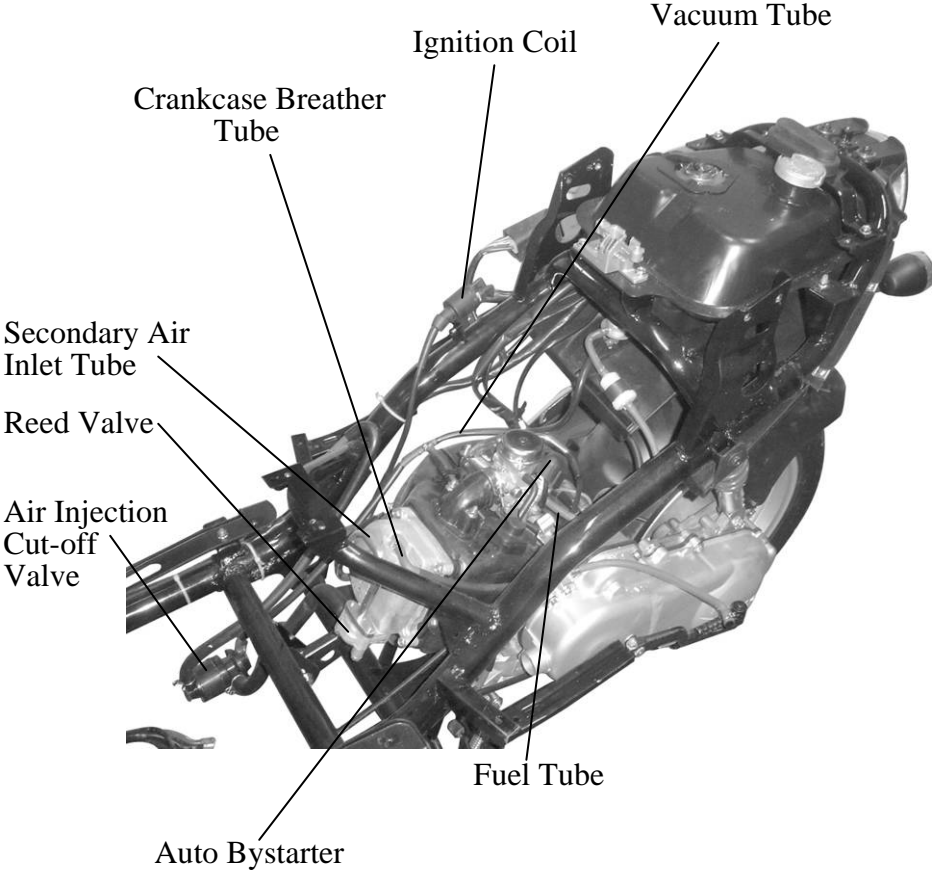
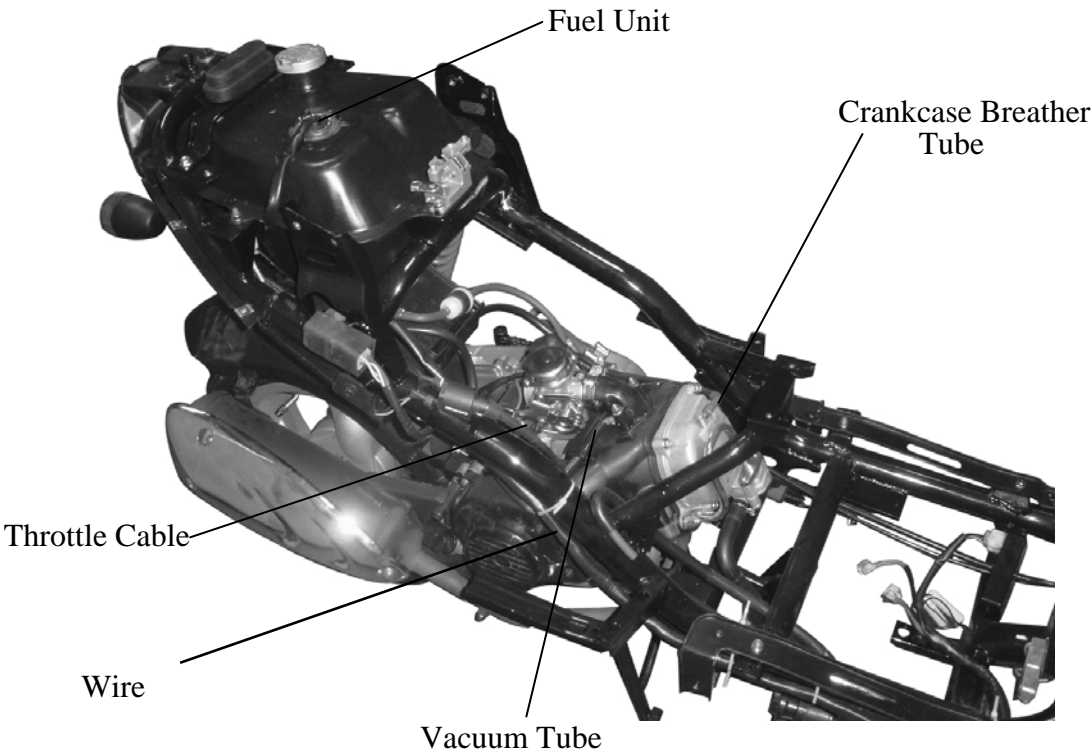

1. GENERAL INFORMATION

AGILITY 125

WIRING DIAGRAM

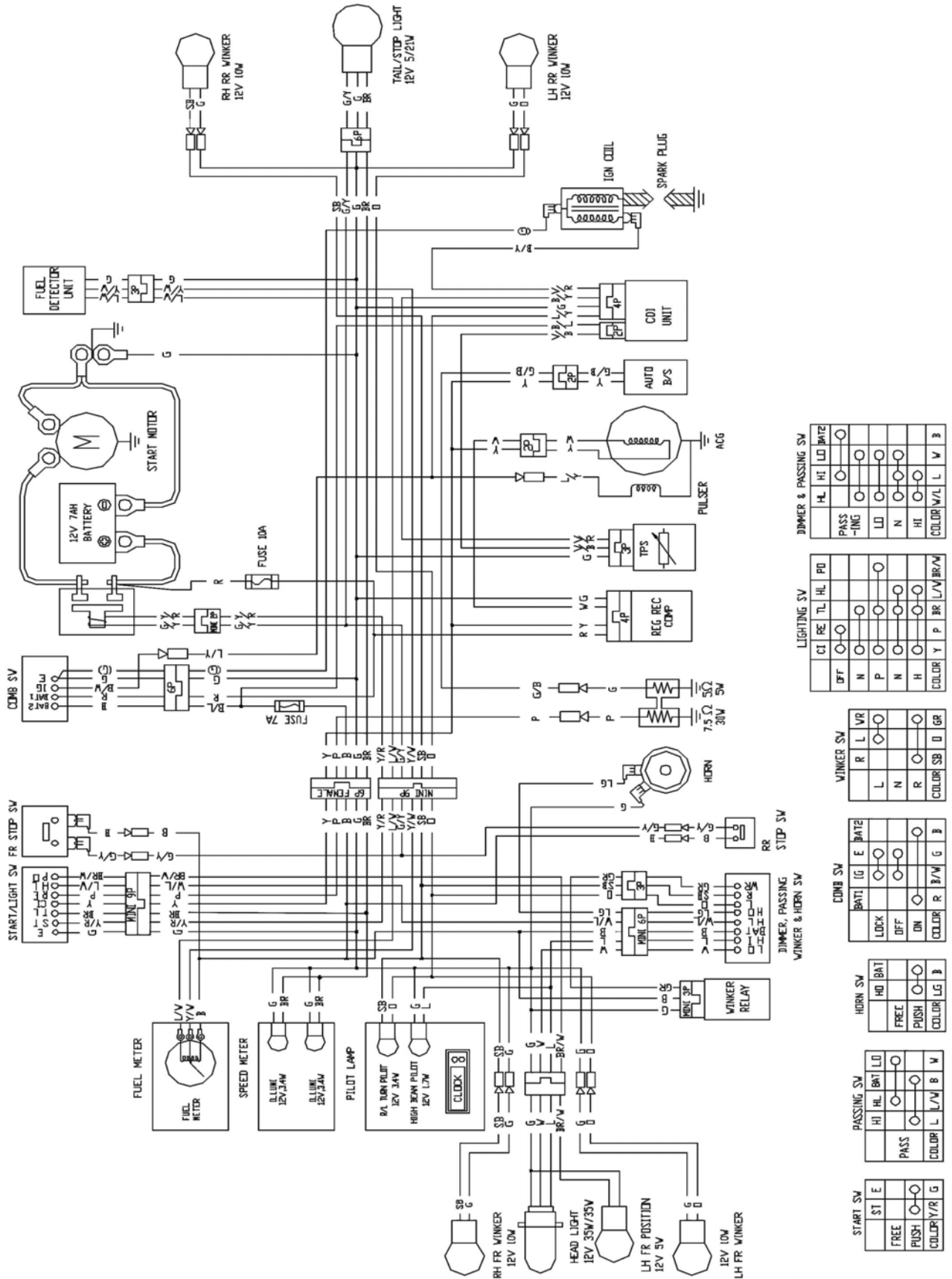

TROUBLESHOOTING

ENGINE WILL NOT START OR IS HARD TO START

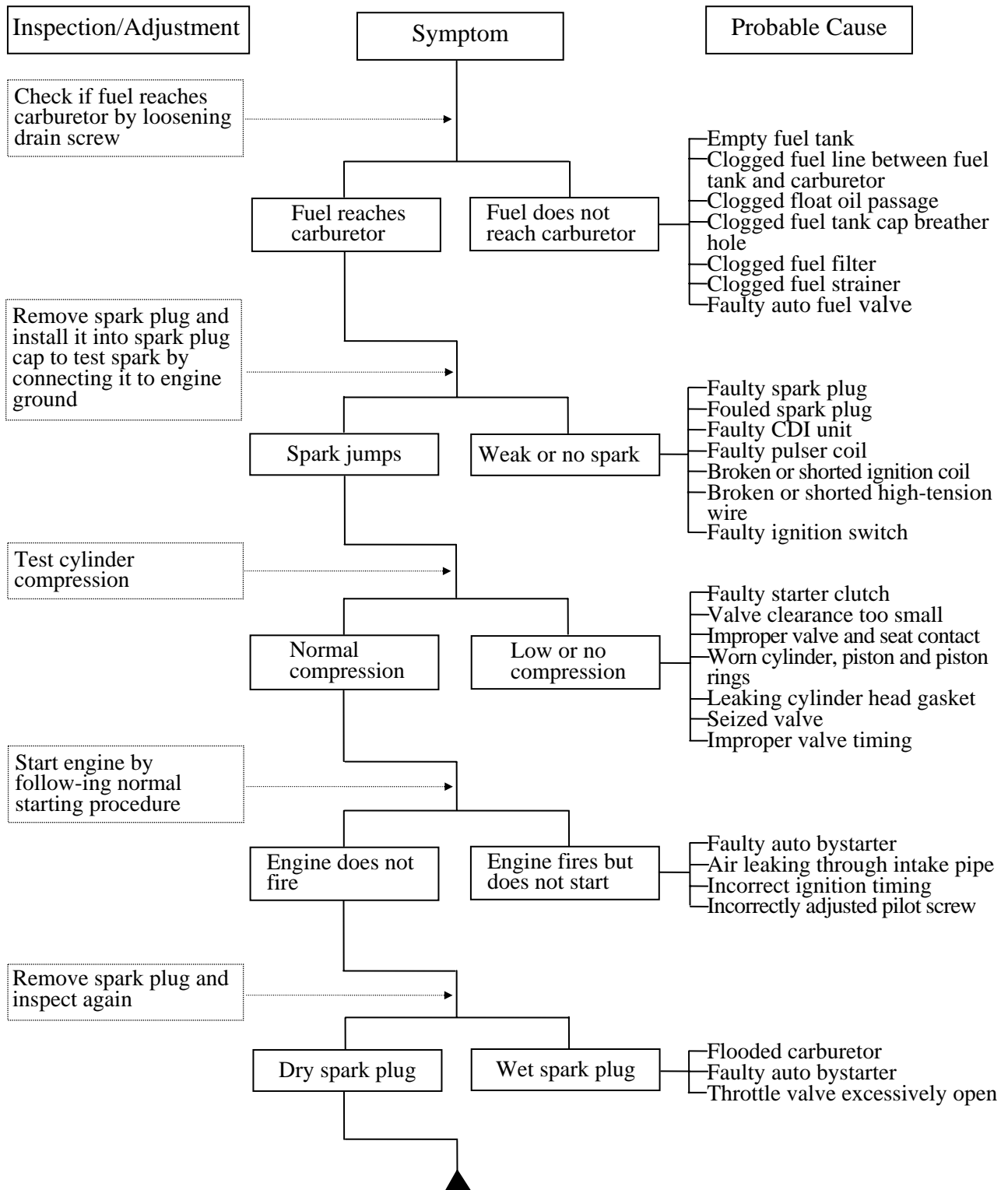

1. GENERAL INFORMATION

AGILITY 125

ENGINE LACKS POWER

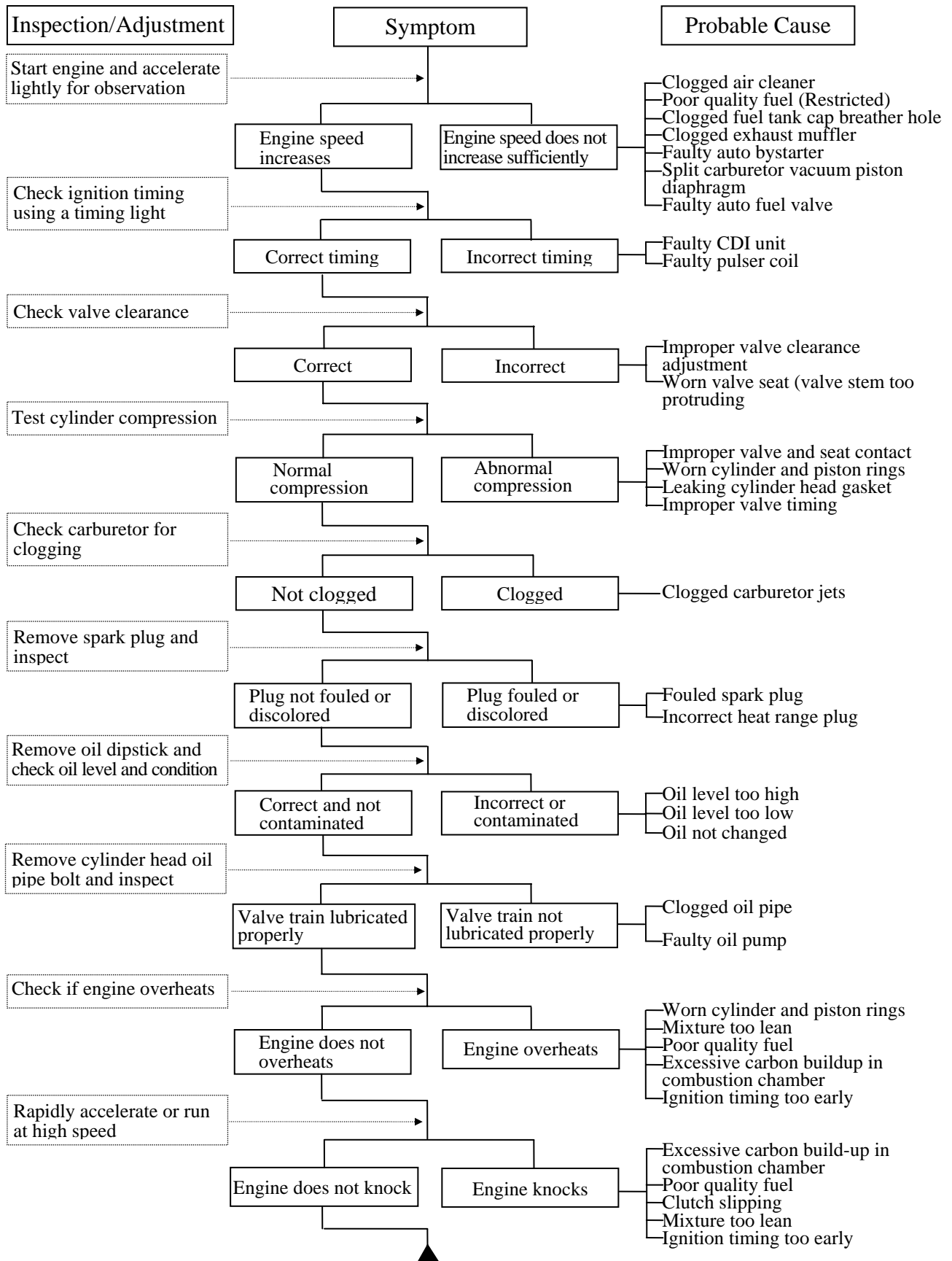

POOR PERFORMANCE (ESPECIALLY AT IDLE AND LOW SPEEDS)

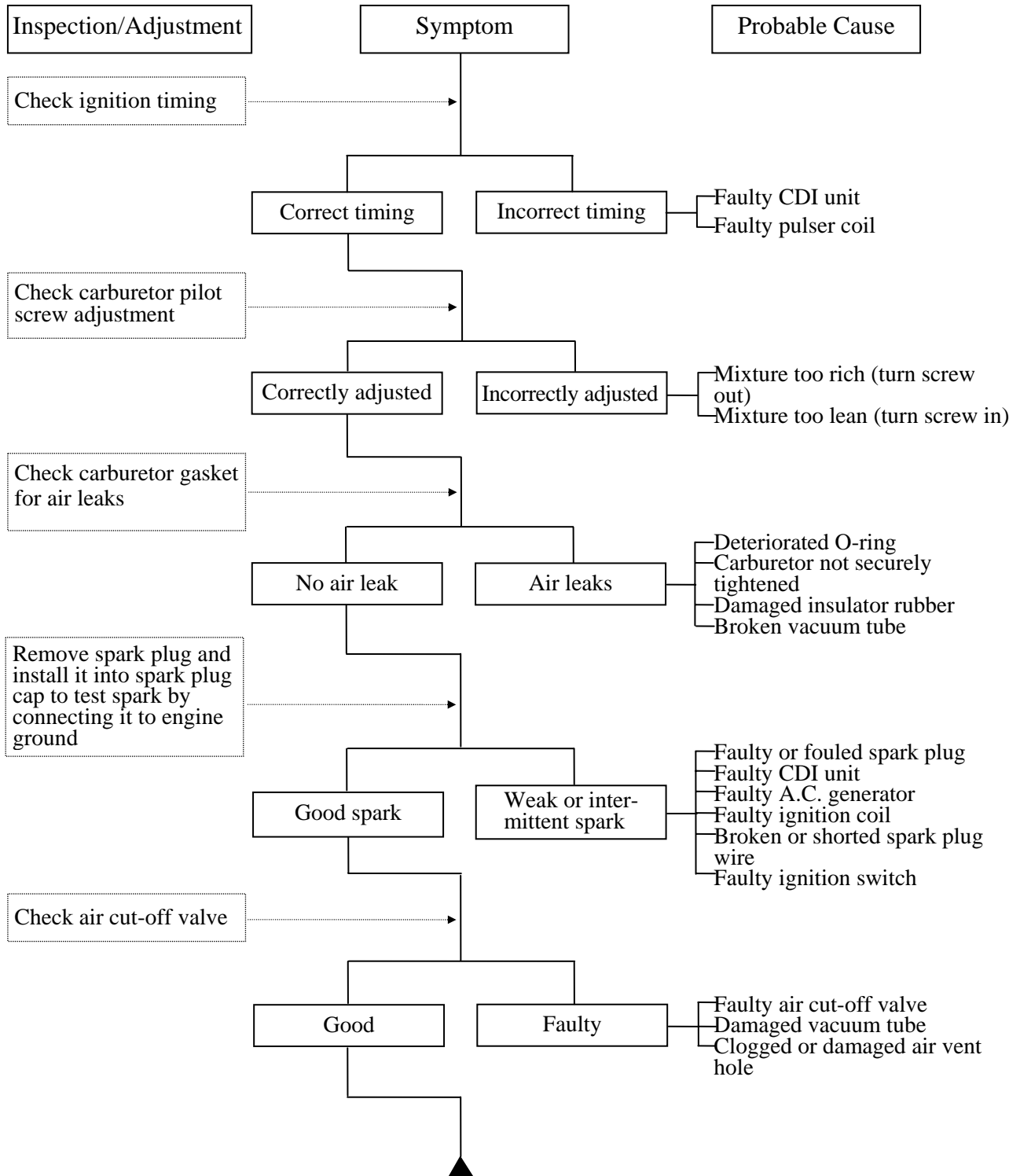

1. GENERAL INFORMATION

AGILITY 125

POOR PERFORMANCE (AT HIGH SPEED)

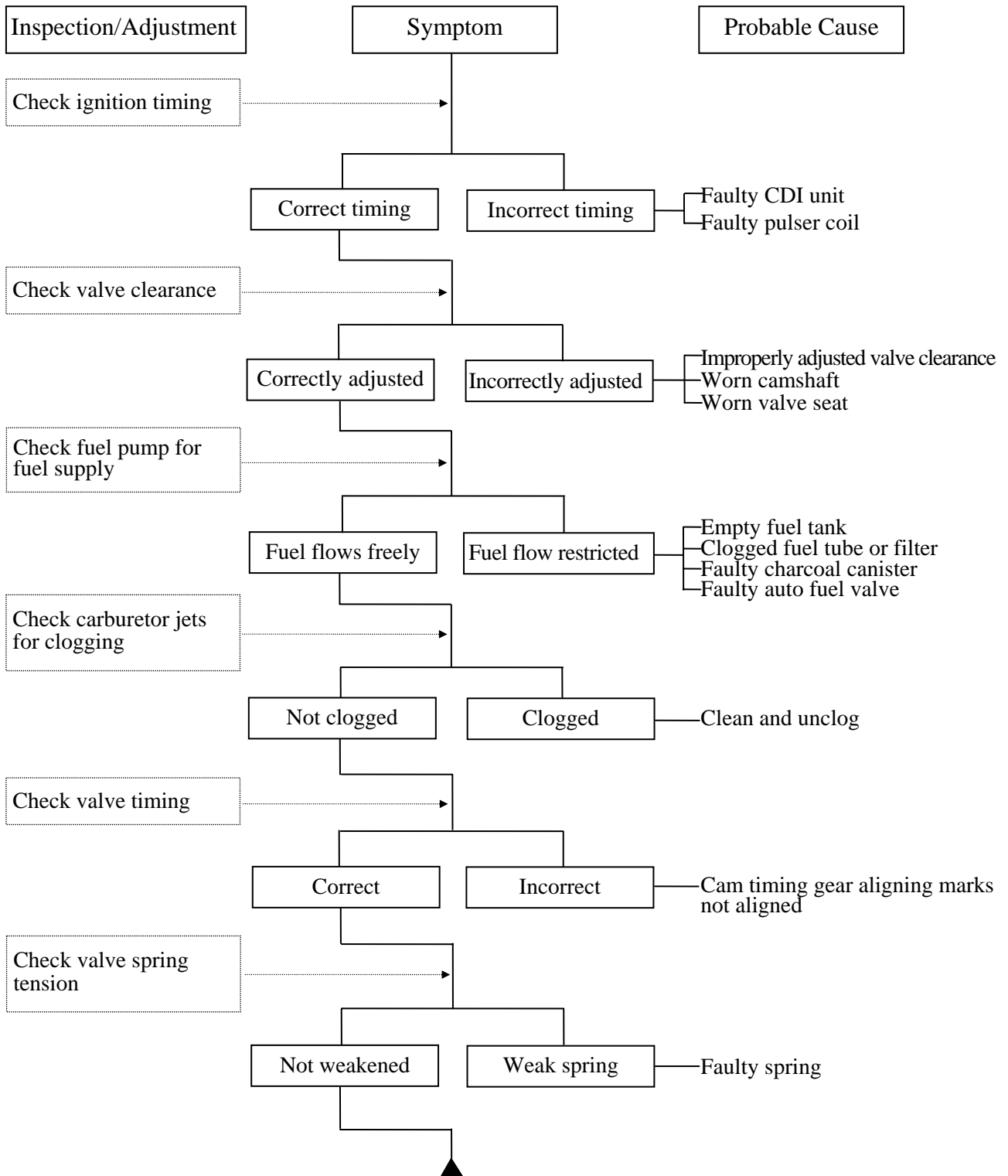

1. GENERAL INFORMATION

AGILITY 125

POOR CHARGING (BATTERY OVER DISCHARGING OR OVERCHARGING)

Undercharging

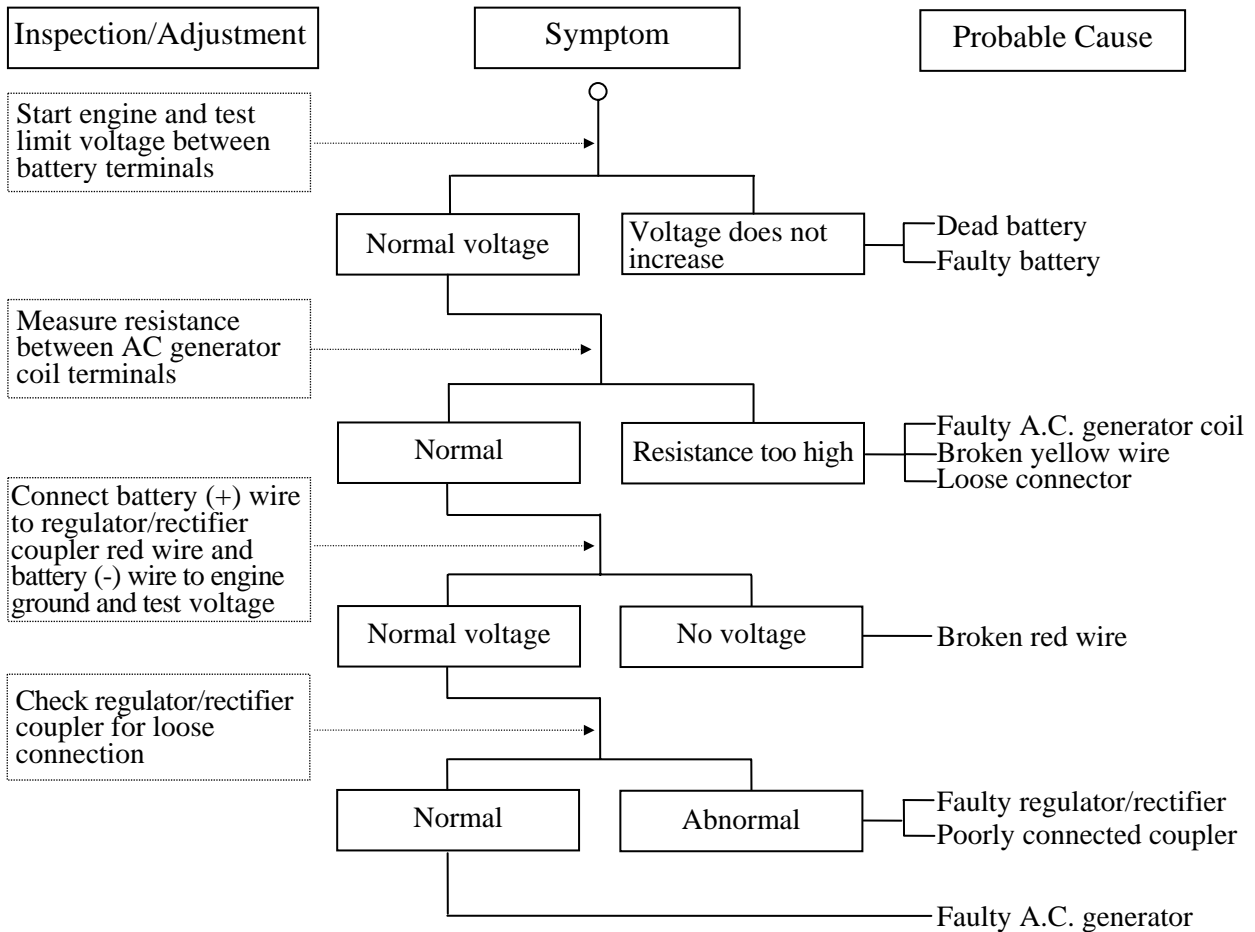

Overcharging

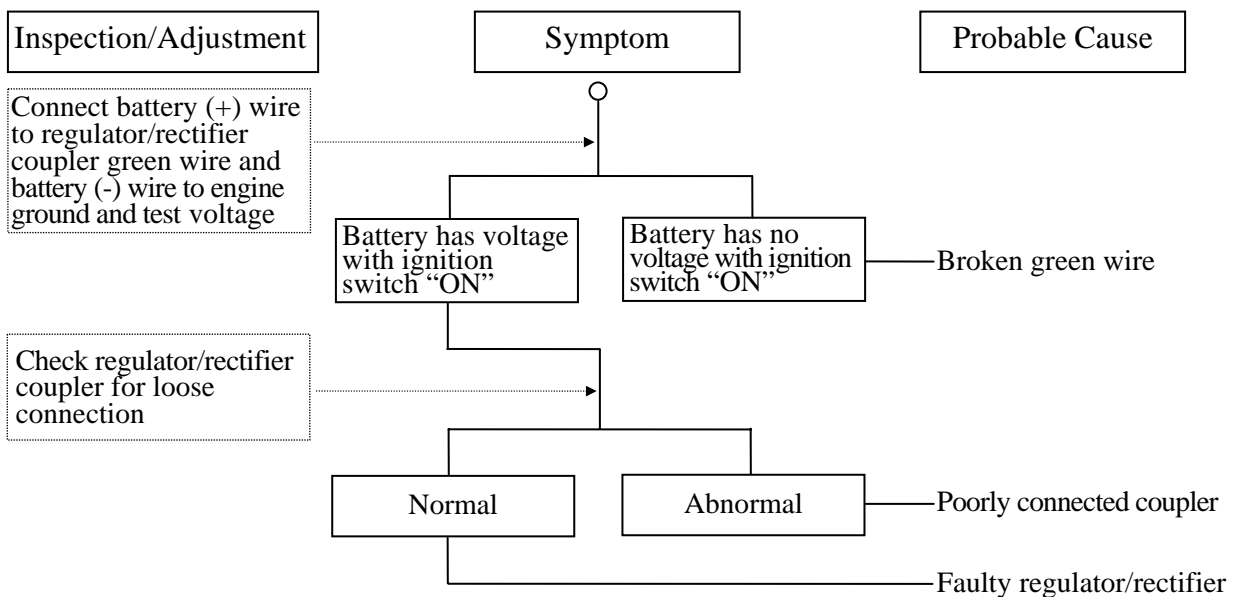

1. GENERAL INFORMATION

AGILITY 125

NO SPARK AT SPARK PLUG

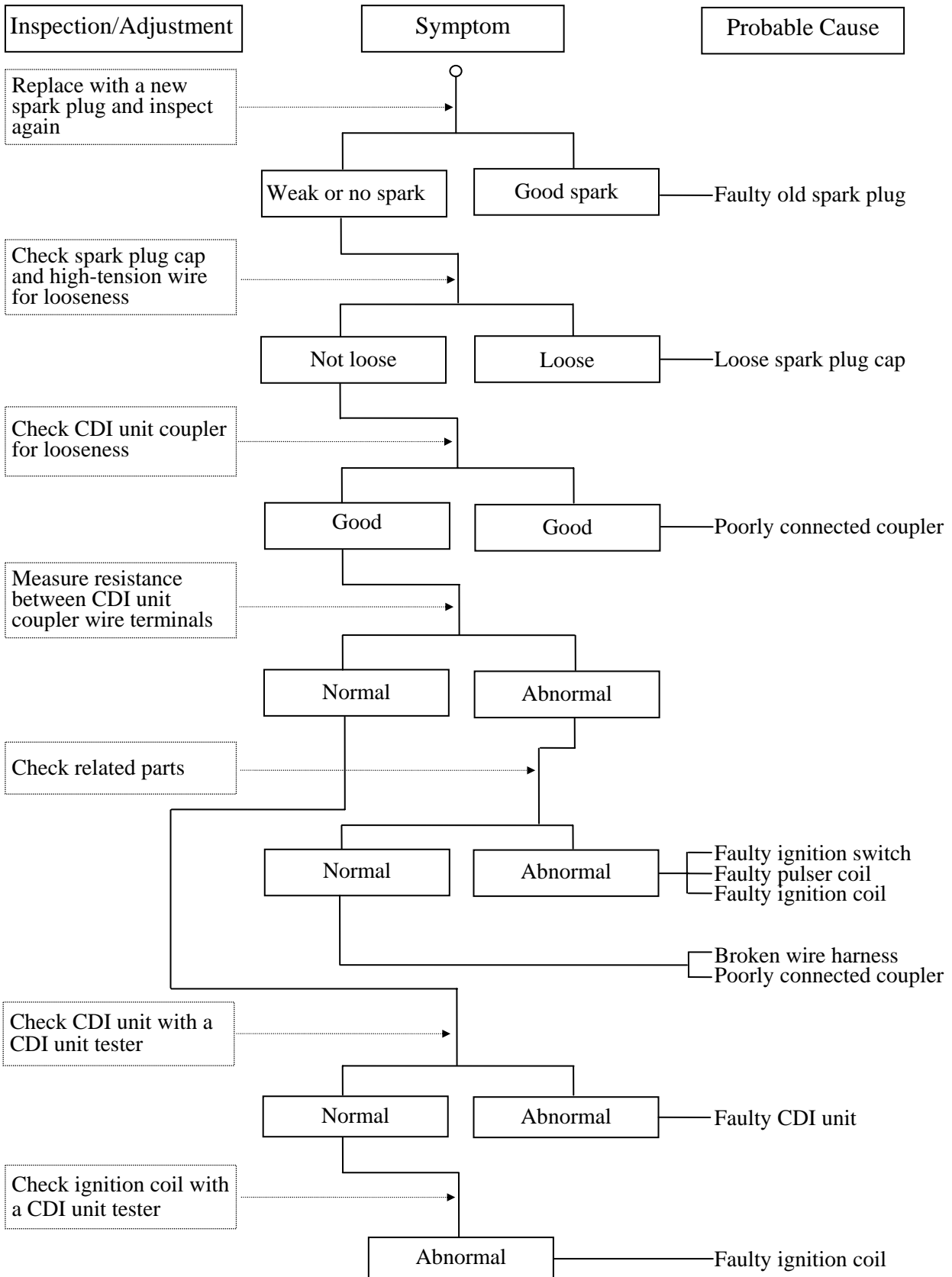

SCHEMATIC DRAWING

2

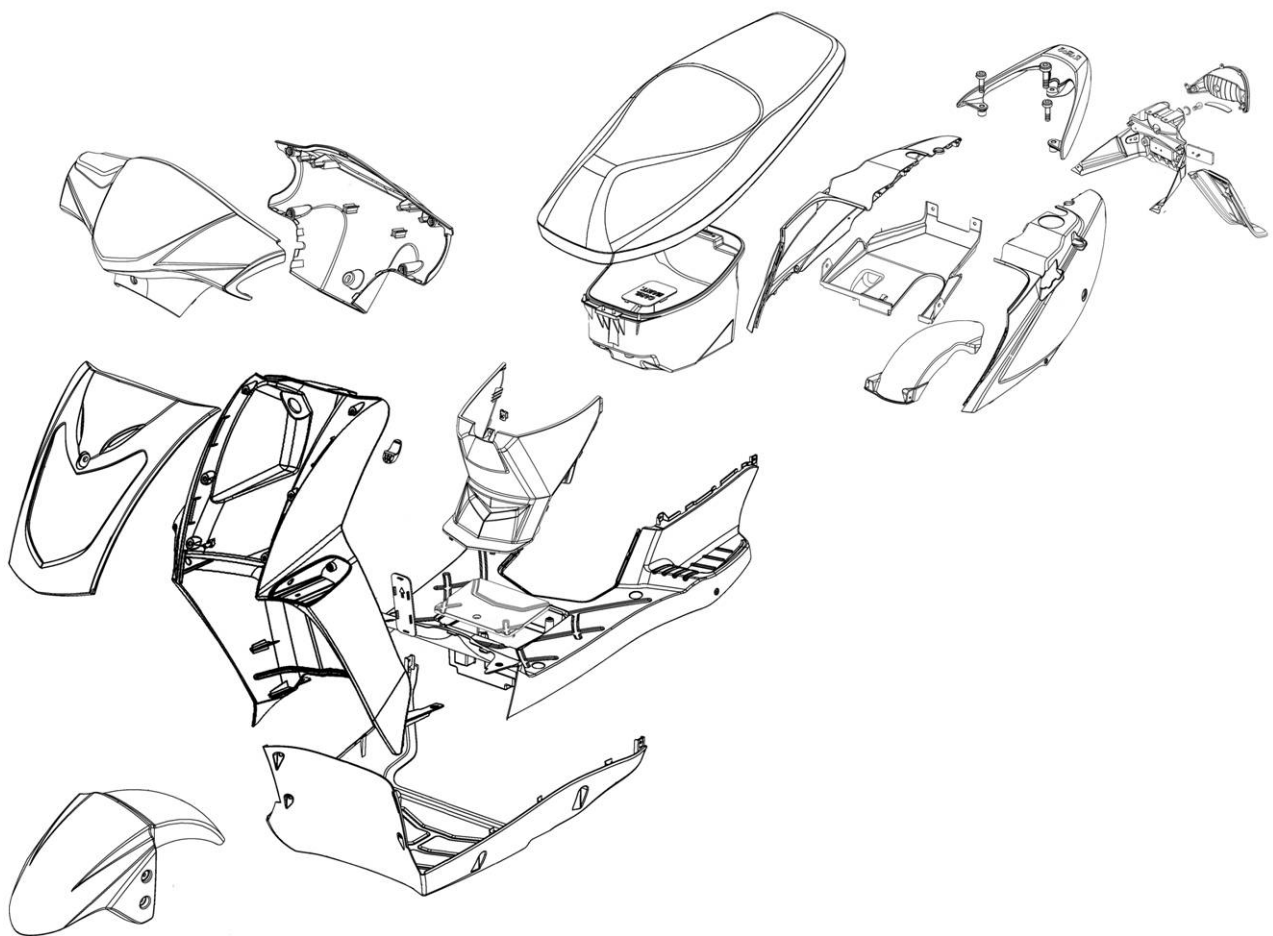

SERVICE INFORMATION	2-1	EXHAUST MUFFLER REMOVAL	2-5
FRAME COVERS	2-2		

SERVICE INFORMATION

GENERAL INSTRUCTIONS

- When removing frame covers, use special care not to pull them by force because the cover joint claws may be damaged.

Items Related for Removal

- Handlebar front cover ——— Handlebar rear cover
Headlight wire connector
- Handlebar rear cover ——— Speedometer cable and instrument light
wire connectors, etc.
- Frame body cover ——— Met-in box, rear grip, rear turn signal
lights, floor board
- Floor board ——— Frame body cover
Battery and wire connectors
- Front tool box ——— Front cover, floor board

TORQUE VALUES

- | | |
|--------------------------------|--------------|
| Exhaust muffler joint lock nut | 1.0~1.4kgf-m |
| Exhaust muffler lock bolt | 3.0~3.6kgf-m |

2. FRAME COVERS/EXHAUST MUFFLER

AGILITY 125

FRAME COVERS

FRONT COVER REMOVAL

Remove the screw on the front of the front cover.

Remove the six screws on the back of the front cover.

Remove the front cover.

The installation sequence is the reverse of removal.

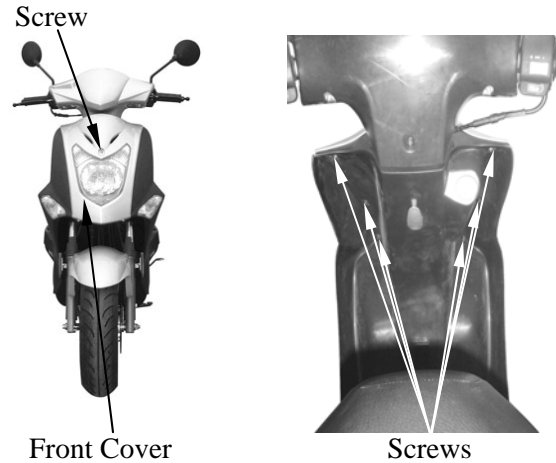

HANDLEBAR FRONT/REAR COVER REMOVAL

HANDLEBAR FRONT COVER REMOVAL

Remove the handlebar front cover screw.

Remove the five screws attaching the handlebar front cover.

Disconnect the headlight wire connector and remove the handlebar front cover.

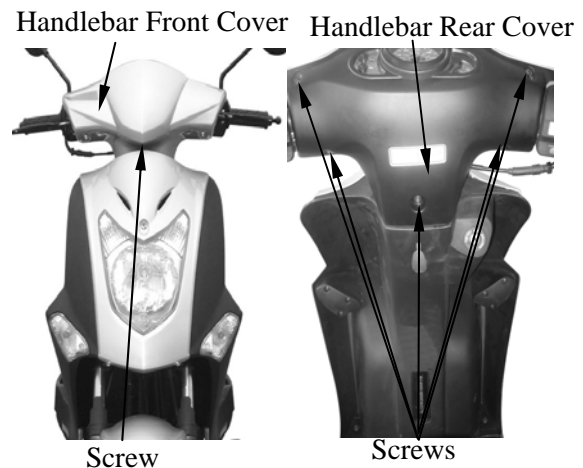

HANDLEBAR REAR COVER REMOVAL

Disconnect the speedometer cable, right and left handlebar switch couplers, and the stop switch wire connectors.

Remove the bolt attaching the handlebar rear cover.

Remove two screws inside the handlebar rear cover and remove the handlebar rear cover.

The installation sequence is the reverse of removal.

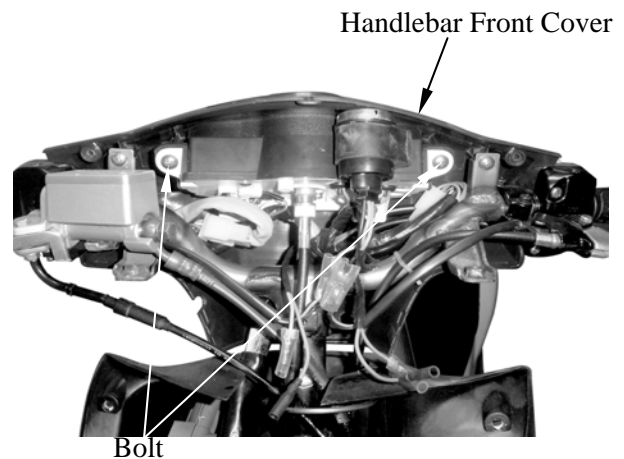

2. FRAME COVERS/EXHAUST MUFFLER

MET-IN BOX REMOVAL

Open the seat and remove the two nuts and three bolt attaching the met-in box.
Remove the met-in box .

Bolt



Bolts

FRAME BODY COVER REMOVAL

Remove the center cover.

Center Cover



Remove the three bolts attaching the rear carrier.
Remove the rear carrier.

Rear Carrier

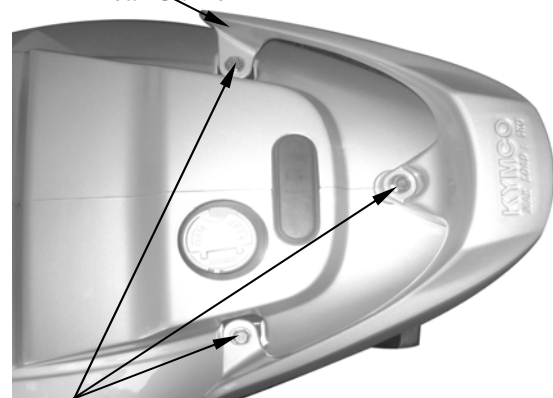

Bolts

Remove the six screws on the rear part of the frame body cover.
Remove the two screws on the front of the frame body cover.

Screws

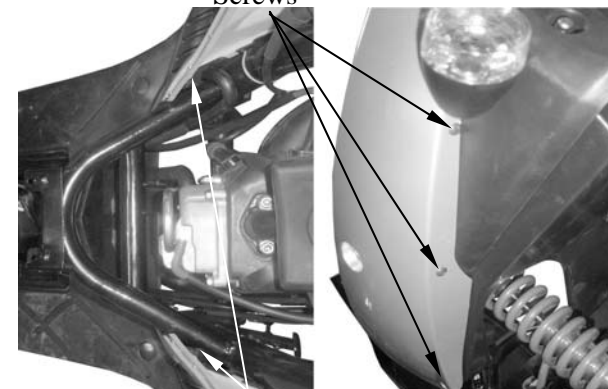

Screws

2. FRAME COVERS/EXHAUST MUFFLER

AGILITY 125

Disconnect the seat lock wire.

Remove the frame body cover.

The installation sequence is the reverse of remove

Remove the three bolts attaching each of the right and left side covers.

Remove the right and left side covers.

* During removal, do not pull the joint claws forcedly to avoid damage.
When installing, be sure to connect the seat lock wire.

Seat Lock Wire



Frame Body Cover

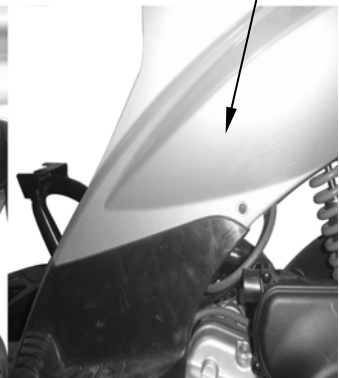

FLOOR BOARD REMOVAL

Remove the rear carrier and rear seat. (⇒2-3)

Remove the met-in box. (⇒2-3)

Remove the frame body cover. (⇒2-4)

Remove the eight bolts attaching the floor board.

Remove the floor board.

Bolts

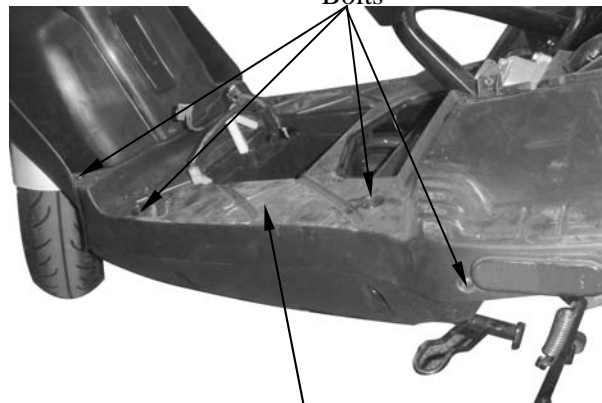

Floor Board.

BOTTOM PROTECTOR COVER REMOVAL

Remove the sixbolts on the bottom protector cover.

Remove the bottom protector cover.

Bottom Protector Cover

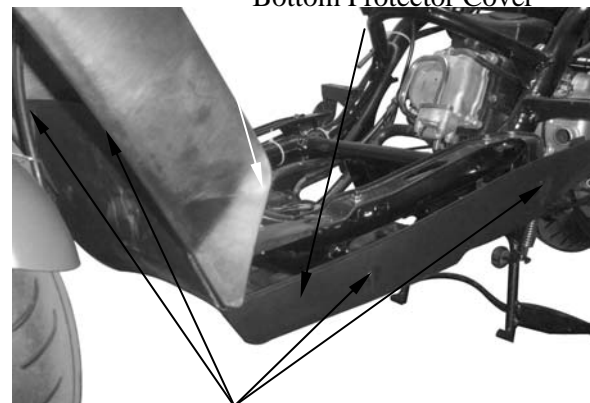

Bolts

2. FRAME COVERS/EXHAUST MUFFLER

AGILITY 125

LEG SHIELD REMOVAL

Remove the bolt leg shield.
Remove the ignition switch decorative ring.
Remove the leg shield.

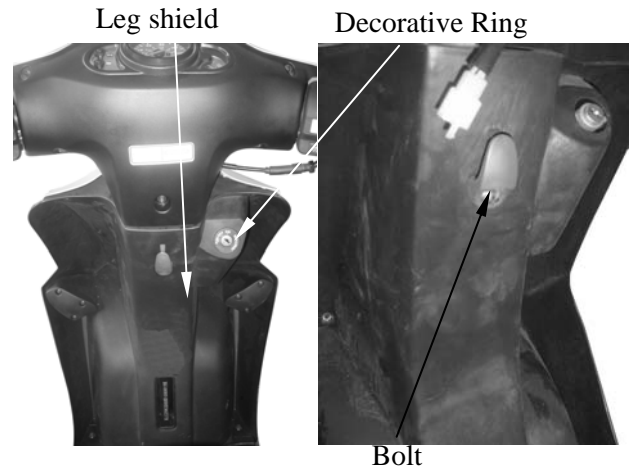

FRONT FENDER REMOVAL

Remove the two bolts attaching the front fender bracket.
Remove the front fender.

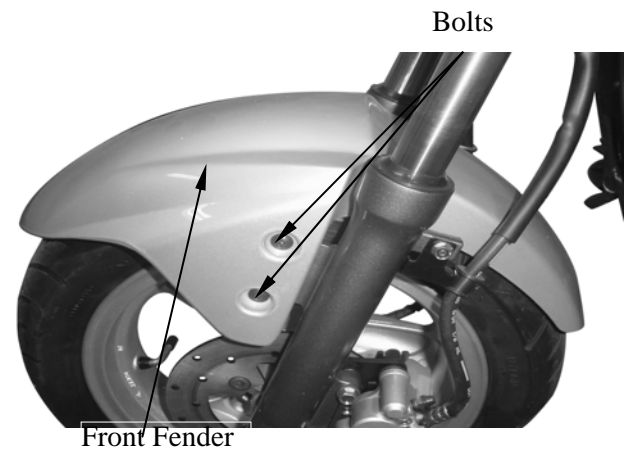

EXHAUST MUFFLER REMOVAL

Remove the two exhaust muffler joint lock nuts.
Remove the two exhaust muffler lock bolts.
Remove the exhaust muffler.
Remove the exhaust muffler joint packing collar.

When installing, first install the exhaust muffler packing collar and then install the exhaust muffler.
First install and tighten the exhaust muffler joint lock nuts. Then, install and tighten the exhaust muffler lock bolts.

Torques:

Exhaust muffler lock bolt: 3.0~3.6kgf-m

Exhaust muffler joint lock nut: 1.0~1.4kgf-m

* Be sure to install a new exhaust muffler packing collar.

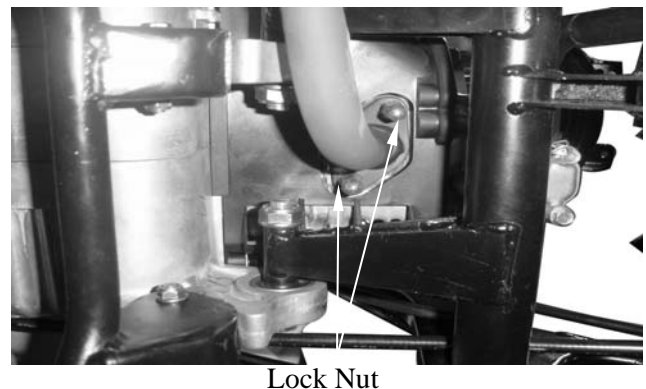
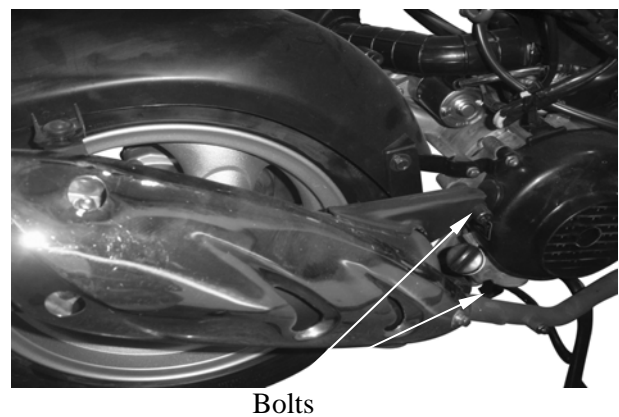

SERVICE INFORMATION.....3-0	FINAL REDUCTION GEAR OIL.....3- 7
MAINTENANCE SCHEDULE.....3-2	DRIVE BELT.....3- 7
FUEL FILTER.....3-3	BRAKE SHOE.....3- 8
THROTTLE OPERATION.....3-3	BRAKE ADJUSTING NUT.....3- 8
AIR CLEANER3-4	HEADLIGHT AIM3- 9
SPARK PLUG3-4	CLUTCH SHOE WEAR.....3- 9
VALVE CLEARANCE.....3-5	SUSPENSION3- 9
CARBURETOR IDLE SPEED3-5	NUTS/BOLTS/FASTENERS.....3-10
IGNITION TIMING3-6	WHEELS/TIRES.....3-10
CYLINDER COMPRESSION.....3-6	STEERING HANDLEBAR3-11

SERVICE INFORMATION

GENERAL

WARNING

- Before running the engine, make sure that the working area is well-ventilated. Never run the engine in a closed area. The exhaust contains poisonous carbon monoxide gas which may cause death to people.
- Gasoline is extremely flammable and is explosive under some conditions. The working area must be well-ventilated and do not smoke or allow flames or sparks near the working area or fuel storage area.

SPECIFICATIONS

ENGINE

Throttle grip free play : 2~6mm
 Spark plug gap : 0.6~0.7mm
 Spark plug : CHAMPION-P-RZ9HC

Valve clearance : IN: 0.12mm
 : EX: 0.12mm

Idle speed : 1700 ±100rpm

Engine oil capacity:

At disassembly : 0.9 liter
 At change : 0.8 liter

Gear oil capacity :

At disassembly : 0.2 liter
 At change : 0.19 liter

3. INSPECTION/ADJUSTMENT

Cylinder compression : 13 kg/cm²

Ignition timing: BTDC 27° ±2° /4000rpm

CHASSIS

Front brake free play: 10~20mm

Rear brake free play : 10~20mm

TIRE PRESSURE

	1 Rider	2 Riders
Front	1.5kg/cm ²	1.75kg/cm ²
Rear	2.0kg/cm ²	2.25kg/cm ²

TIRE SIZE:

Front : 120/70-12

Rear : 130/70-12

TORQUE VALUES

Front axle nut 5.0~7.0kgf-m

Rear axle nut 11~13kgf-m

3. INSPECTION/ADJUSTMENT

MAINTENANCE SCHEDULE

Perform the periodic maintenance at each scheduled maintenance period.

I: Inspect, and Clean, Adjust, Lubricate or Replace if necessary.

A: Adjust C: Clean R: Replace T: Tighten

Item	Frequency	Whichever comes first ⇄ ↓	Regular Service Mileage (km)											
			1000	2000	3000	4000	5000	6000	7000	8000	9000	10000	11000	12000
Engine oil			R New Motorcycle 300km	R		R		R		R		R		R
Engine oil filter screen						C				C				
Fuel filter screen												R		
Gear oil	Note 3		R New motorcycle 300km				R					R		
Valve clearance				A		A				A				A
Carburetor						I				I				C
Air Cleaner	Note 2,3		Replace at every 2000km											
Spark plug			Clean at every 3000km and replace if necessary											
Brake system			I	I	I	I	I	I	I	I	I	I	I	I
Drive belt										I				
Suspension						I				I				I
Nut, bolt, fastener										I				
Tire						I				I				I
Steering head bearing			I						I					I

- In the interest of safety, we recommend these items should be serviced only by an authorized KYMCO motorcycle dealer.

Note: 1. For higher odometer readings, repeat at the frequency interval established here.

2. Service more frequently when riding in dusty or rainy areas.

3. Service more frequently when riding in rain or at full throttle.

3. INSPECTION/ADJUSTMENT

FUEL FILTER

Remove the met-in box. (⇒2-3)
 Check the fuel lines and replace any parts which show signs of deterioration, damage or leakage.

* Do not smoke or allow flames or sparks in your working area.

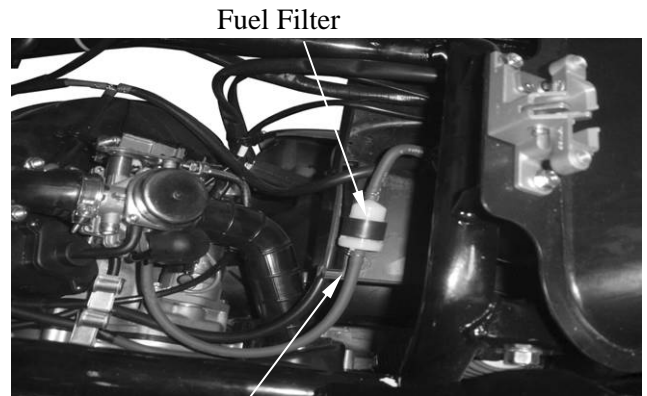

Fuel Filter

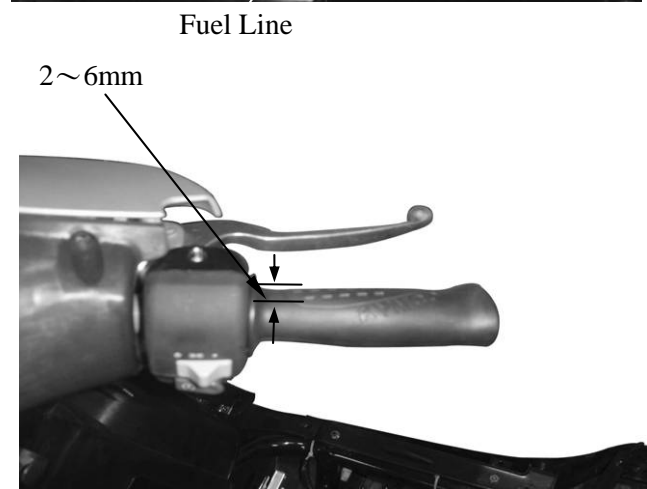

Fuel Line

2~6mm

THROTTLE OPERATION

Check the throttle grip for smooth movement.
 Measure the throttle grip free play.

Free Play: 2~6mm

Major adjustment of the throttle grip free play is made at the carburetor side.
 Adjust by loosening the lock nut and turning the adjusting nut.



Lock Nut

Adjusting Nut

Minor adjustment is made with the adjusting nut at the throttle grip side.
 Slide the rubber cover out and adjust by loosening the lock nut and turning the adjusting nut.

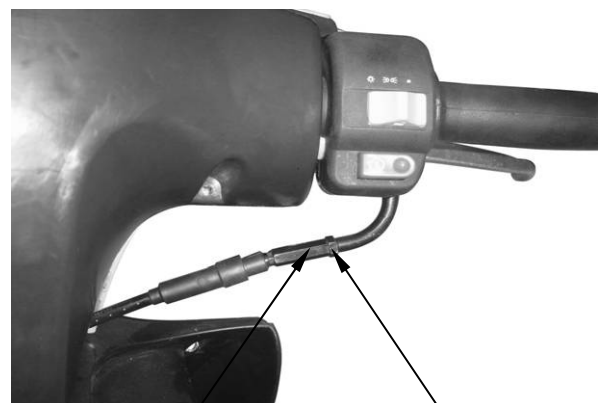

Adjusting Nut

Lock Nut

3. INSPECTION/ADJUSTMENT

AIR CLEANER

AIR CLEANER REPLACEMENT

Remove the air cleaner case cover screws and the cover by removing the six screws.

Remove the air cleaner element by removing the four screws.

Check the element and replace it if it is excessively dirty or damaged.



Air Cleaner Case Cover

CHANGE INTERVAL

More frequent replacement is required when riding in unusually dusty or rainy areas.

- * The air cleaner element has a viscous type paper element. Do not clean it with any fluid.
- * Be sure to install the air cleaner element and cover securely.

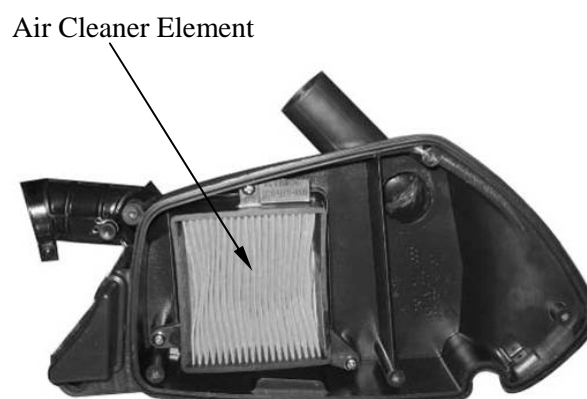

SPARK PLUG

Remove the spark plug.

Check the spark plug for wear and fouling deposits.

Clean any fouling deposits with a spark plug cleaner or a wire brush.

Specified Spark Plug:

CHAMPION-P-RZ9HC



Measure the spark plug gap.

Spark Plug Gap: 0.6~0.7mm

- * When installing, first screw in the spark plug by hand and then tighten it with a spark plug wrench.

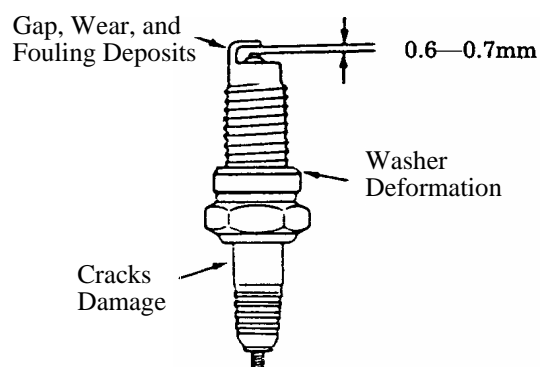

VALVE CLEARANCE

* Inspect and adjust valve clearance while the engine is cold (below 35°C).

- Remove the frame cover. (⇒2-3)
- Remove the six bolts on the cylinder head cover.
- Remove the cylinder head cover. (⇒7-3)
- Remove the cylinder head cover..

Cylinder Head Cover

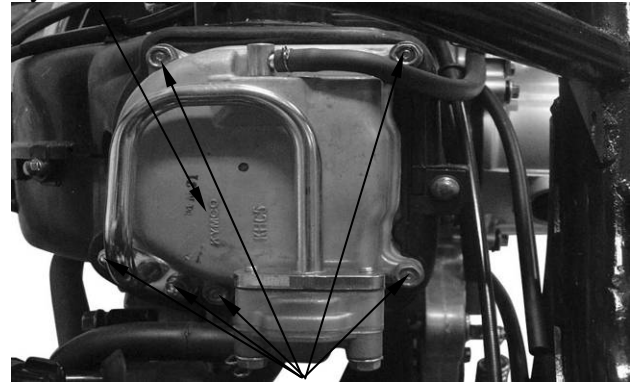

Bolts

Turn the flywheel counterclockwise so that the "T" mark on the flywheel aligns with the index mark on the crankcase to bring the round hole on the camshaft gear facing up to the top dead center on the compression stroke.

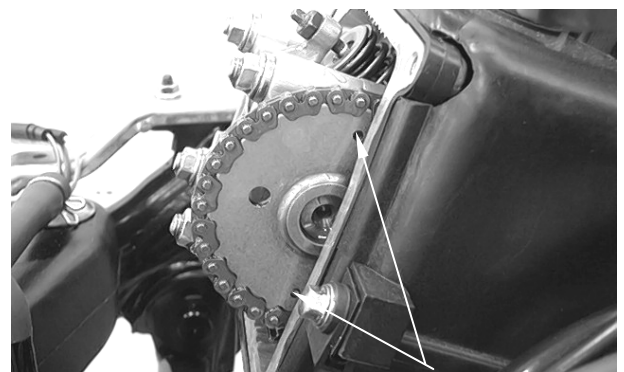

Round Hole

Inspect and adjust the valve clearance.

Valve Clearance: IN : 0.04mm
EX: 0.04mm

Loosen the lock nut and adjust by turning the adjusting nut

Special

Tappet Adjuster

* • Check the valve clearance again after the lock nut is tightened.

Tappet Adjuster

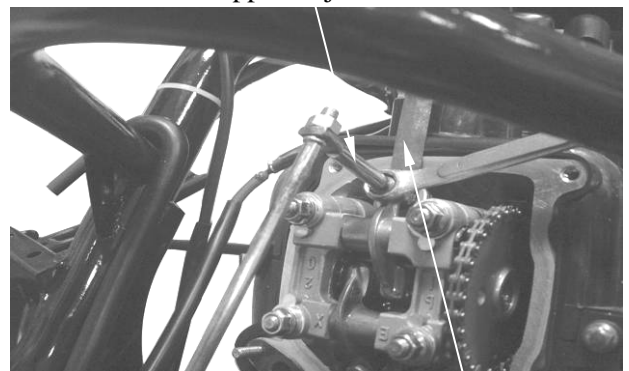

Feeler Gauge

CARBURETOR IDLE SPEED

* • The engine must be warm for accurate idle speed inspection and adjustment.

Remove the inspection cover.
Warm up the engine before this operation.
Start the engine and connect a tachometer.
Turn the throttle stop screw to obtain the specified idle speed.

Idle Speed: 1900±100rpm

When the engine misses or run erratic, adjust the pilot screw.

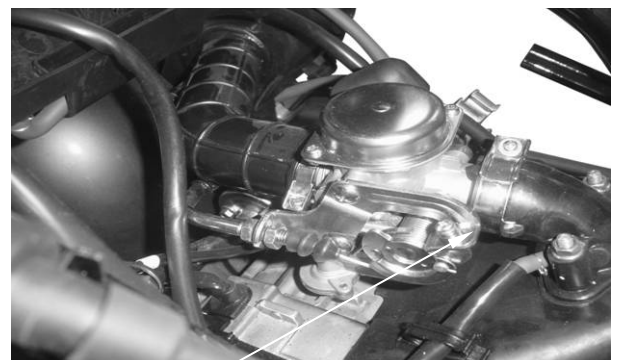

Throttle Stop Screw

3. INSPECTION/ADJUSTMENT

FILLY LX 125

IGNITION TIMING

* The CDI unit is not adjustable. If the ignition timing is incorrect, check the ignition system. (⇒15-5)

Remove the right of the fan cover.

Timing Hole Cap



Check the ignition timing with a timing light. When the engine is running at idle speed, the ignition timing is correct if the “F” mark on the flywheel aligns with the index mark on the crankcase.

Timing Light

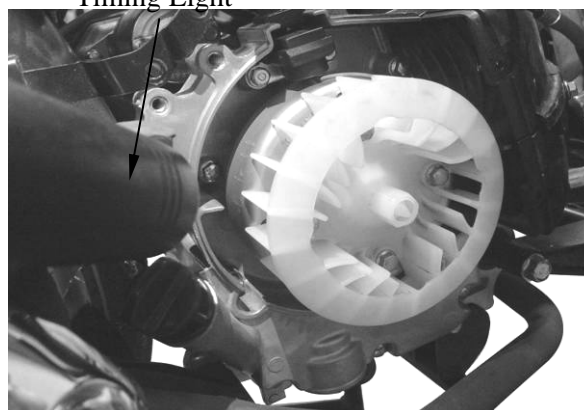

Also use a timing light to check the advance. Raise the engine speed to 4,000rpm and the index mark on the crankcase cover should be aligned with the advance mark on the flywheel.

CYLINDER COMPRESSION

Warm up the engine before compression test. Remove the met-in box and center cover. (⇒2-3)

Remove the spark plug.

Insert a compression gauge.

Open the throttle valve fully and push the starter button to test the compression.

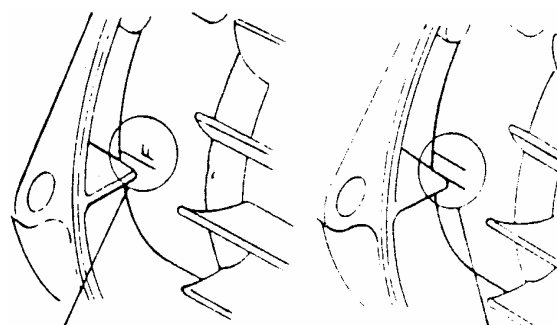

“F” Mark

Advance Mark

Compression: 16kg/cm²rpm

If the compression is low, check for the following:

- Leaky valves
- Valve clearance too small
- Leaking cylinder head gasket
- Worn piston rings
- Worn piston/cylinder

If the compression is high, it indicates that carbon deposits have accumulated on the combustion chamber and the piston head.

Compression Gauge



3. INSPECTION/ADJUSTMENT

FINAL REDUCTION GEAR OIL OIL LEVEL CHECK

- * Place the motorcycle on its main stand on level ground for oil level check.

Stop the engine and remove the oil check bolt. The oil level shall be at the oil check bolt hole.

If the oil level is low, add the recommended oil to the proper level.

Recommended Oil: SAE90#

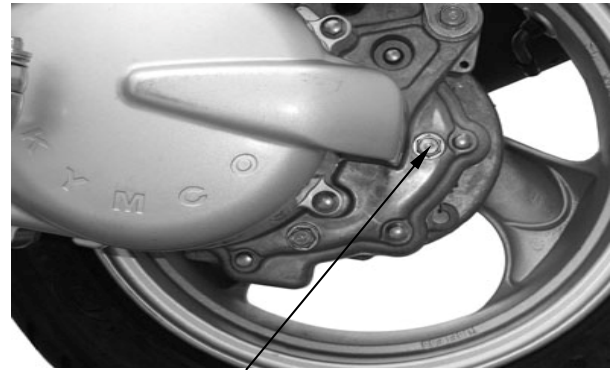

Oil Check Bolt/Sealing Washer

Install the oil check bolt.

- * Make sure that the sealing washer is in good condition.



Oil Check Bolt Hole

OIL CHANGE

Remove the oil check bolt.

Remove the oil drain bolt and drain the oil thoroughly.

Install the oil drain bolt.

Torque: 0.8~1.2kgf-m

- * Make sure that the sealing washer is in good condition.

Fill with the recommended oil.

Oil Capacity: At disassembly : 0.11 liter
At change : 0.10 liter

Reinstall the oil check bolt and check for oil leaks.

Torque: 0.8~1.2kgf-m

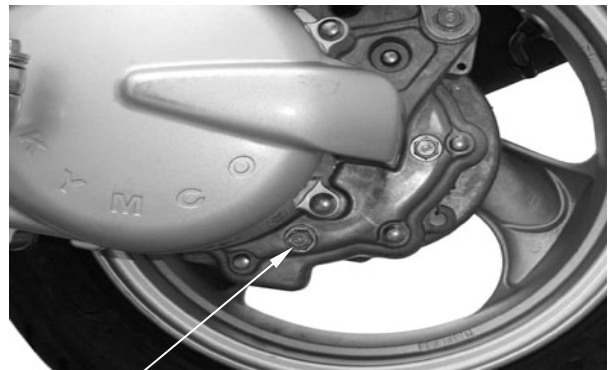

Oil Drain Bolt/ Sealing Washer

DRIVE BELT

Remove the left crankcase cover. (⇒9-2)

Inspect the drive belt for cracks or excessive wear.

Replace the drive belt with a new one if necessary and in accordance with the Maintenance Schedule.

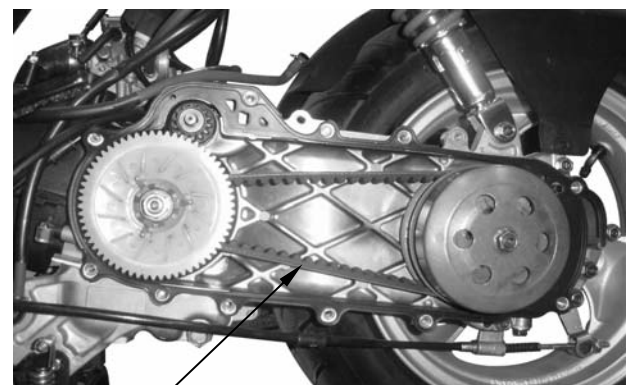

Drive Belt

3. INSPECTION/ADJUSTMENT

REAR BRAKE

Measure the rear brake lever free play.

Free Play: 10~20mm



BRAKE ADJUSTING NUT

If the free play do not fall within the limit, adjust by turning the adjusting nut.

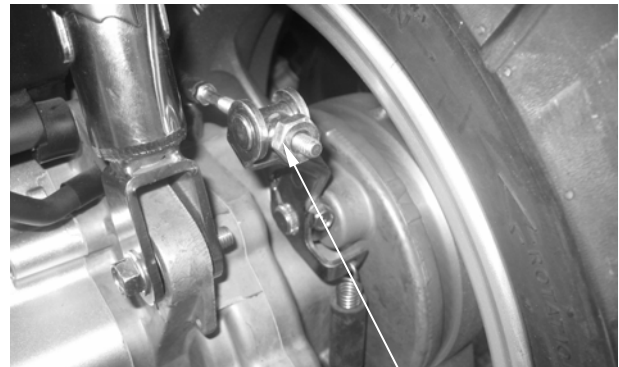

Adjusting Nut

BRAKE FLUID

Turn the steering handlebar upright and check if the rear brake fluid level should be between the upper and lower level lines.

Specified Brake Fluid: DOT-4 ◦

Upper Line



Lower Line

3. INSPECTION/ADJUSTMENT

If the free play do not fall within the limit, adjust by turning the adjusting nut.

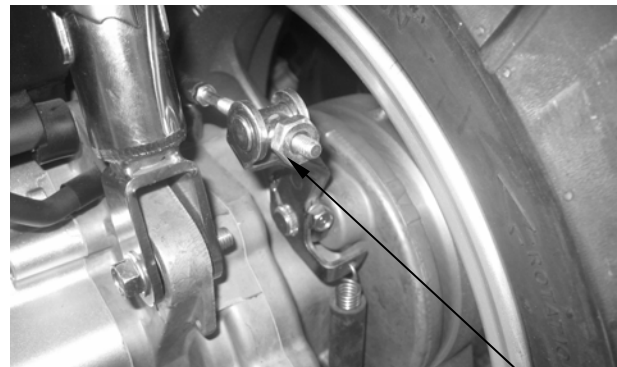

Adjusting Nut

HEADLIGHT AIM

Turn the ignition switch ON and start the engine.

Turn on the headlight switch.

Adjust the headlight aim by turning the headlight aim adjusting screw.

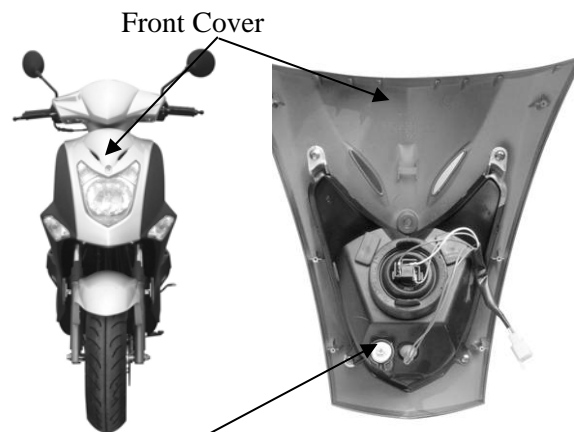

Front Cover

Adjusting Screw

CLUTCH SHOE WEAR

Start the engine and check the clutch operation by increasing the engine speed gradually.

If the motorcycle tends to creep, or the engine stalls, check the clutch shoes for wear and replace if necessary. (⇒9-11)

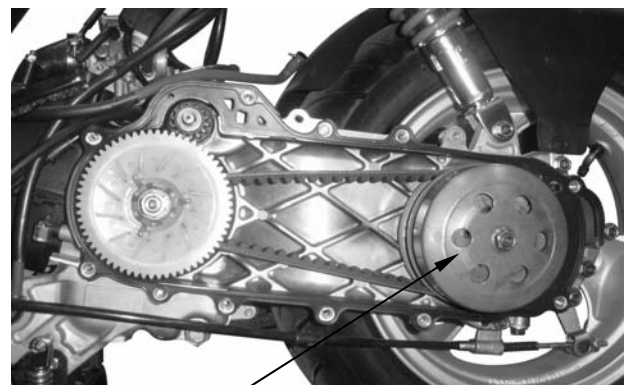

clutch

SUSPENSION

FRONT

Fully apply the front brake lever and check the action of the front shock absorbers by compressing them several times.

Check the entire shock absorber assembly for oil leaks, looseness or damage.



3. INSPECTION/ADJUSTMENT

REAR

Check the action of the rear shock absorber by compressing it several times.
 Check the entire shock absorber assembly for oil leaks, looseness or damage.
 Jack the rear wheel off the ground and move the rear wheel sideways with force to see if the engine hanger bushings are worn.



NUTS/BOLTS/FASTENERS

Check all important chassis nuts and bolts for looseness.
 Tighten them to their specified torque values if any looseness is found. (⇒1-11)

WHEELS/TIRES

Check the tires for cuts, imbedded nails or other damages.

Check the tire pressure.

* Tire pressure should be checked when tires are cold.



TIRE PRESSURE

	1 Rider	2 Riders
Front	1.5kg/cm ²	1.75kg/cm ²
Rear	2.00kg/cm ²	2.25kg/cm ²

TIRE SIZE

Front : 120/70-12
Rear : 130/70-12

Check the front axle nut for looseness.
 Check the rear axle nut for looseness.
 If the axle nuts are loose, tighten them to the specified torques.

Torques: Front : 5.0~7.0kgf-m
Rear : 11~13kgf-m



Front Axle Nut

3. INSPECTION/ADJUSTMENT

STEERING HANDLEBAR

Check that the control cables do not interfere with handlebar rotation.

Raise the front wheel off the ground and check that the steering handlebar rotates freely.

If the handlebar moves unevenly, binds, or has vertical movement, adjust the steering head bearing.



4. LUBRICATION SYSTEM

4

LUBRICATION SYSTEM

SERVICE INFORMATION-----	4- 1
TROUBLESHOOTING-----	4- 1
ENGINE OIL/OIL FILTER -----	4- 2
OIL PUMP-----	4- 2

4. LUBRICATION SYSTEM

SERVICE INFORMATION

GENERAL INSTRUCTIONS

- The maintenance of lubrication system can be performed with the engine installed in the frame.
- Use care when removing and installing the oil pump not to allow dust and foreign matters to enter the engine and oil line.
- Do not attempt to disassemble the oil pump. The oil pump must be replaced as a set when it reaches its service limit.
- After the oil pump is installed, check each part for oil leaks.

SPECIFICATIONS

Item		Standard (mm)	Service Limit (mm)
Oil pump	Inner rotor-to-outer rotor clearance	—	0.12
	Outer rotor-to-pump body clearance	—	0.12
	Rotor end-to-pump body clearance	0.05~0.10	0.2

TROUBLESHOOTING

Oil level too low

- Natural oil consumption
- Oil leaks
- Worn or poorly installed piston rings
- Worn valve guide or seal

Poor lubrication pressure

- Oil level too low
- Clogged oil filter or oil passages
- Not use the specified oil

4. LUBRICATION SYSTEM

ENGINE OIL/OIL FILTER

OIL LEVEL

- * Place the motorcycle upright on level ground for engine oil level check.
- Run the engine for 2~3 minutes and check the oil level after the engine is stopped for 2~3 minutes.

Remove the oil dipstick and check the oil level with the oil dipstick.
If the level is near the lower level, fill to the upper level with the specified engine oil.

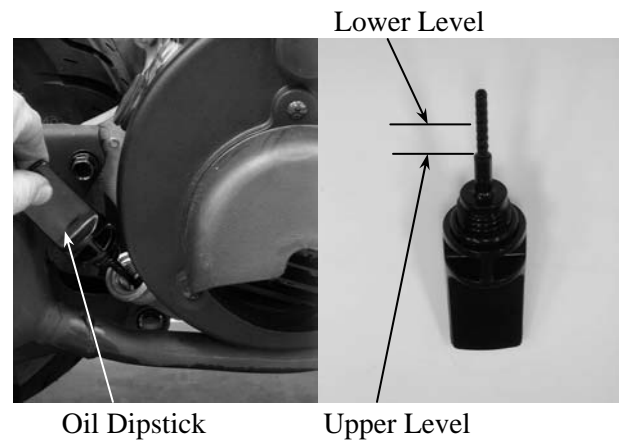

Oil Dipstick

Upper Level

OIL CHANGE

- * The engine oil will drain more easily while the engine is warm.

Remove the oil filter screen cap located on the bottom of the engine to drain the engine oil thoroughly.



Oil Filter Screen Cap

After the oil has been completely drained, check the filter screen O-ring for damage and replace if necessary.
Install the oil filter screen, spring and filter screen cap.

Torque: 1.5kg-m

Fill with the specified SAE15W40#, API: SG engine oil to the proper level.

Oil Capacity: At disassembly : 0.90 liter
At change : 0.80 liter

Check for oil leaks and then start the engine and let it idle for few minutes.
Recheck the oil level.



O-ring

OIL PUMP

REMOVAL

Remove the A.C. generator flywheel.
Remove the nine right crankcase cover bolts and the right crankcase cover.

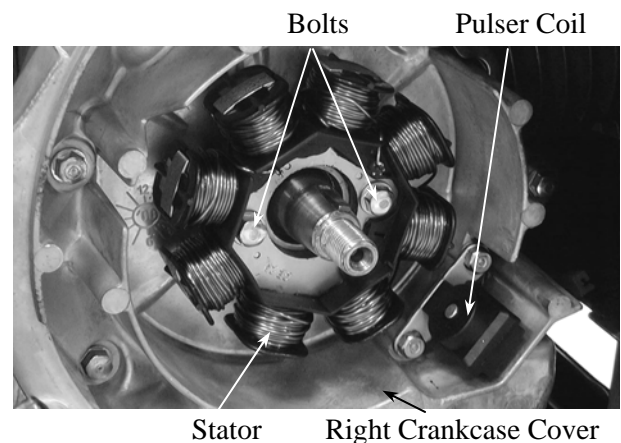

Stator

Right Crankcase Cover

4. LUBRICATION SYSTEM

Remove the gasket and dowel pins.
Remove the starter idle gear and starter clutch.



Gasket

Remove the two bolts and oil separator cover.

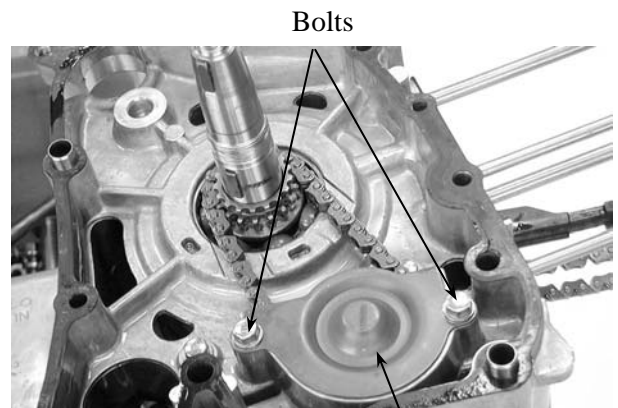

Bolts

Oil Separator Cover

Remove the oil pump driven gear nut to
remove the oil pump driven gear and drive
chain.

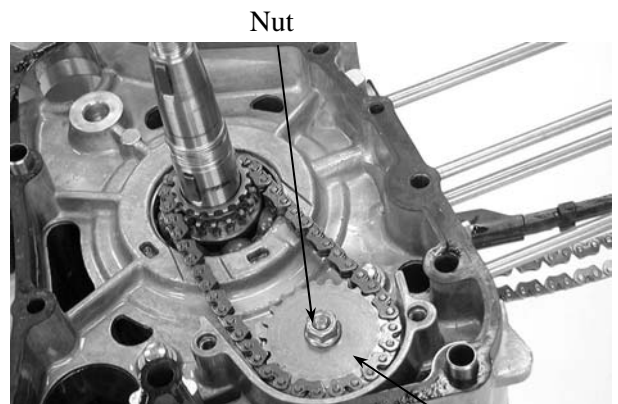

Nut

Oil Pump Driven Gear

Remove the two oil pump mounting bolts
and the oil pump.

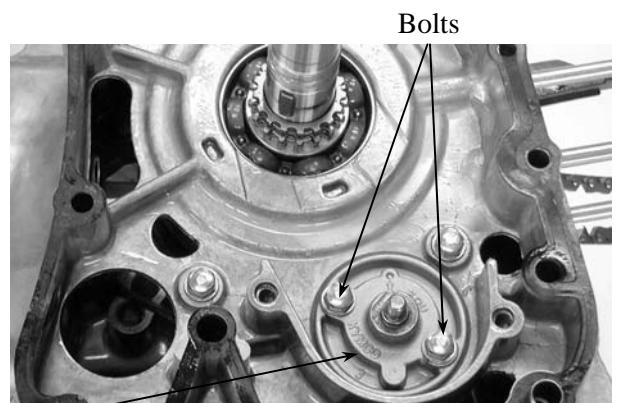

Bolts

Oil Pump

4. LUBRICATION SYSTEM

DISASSEMBLY

Remove the screw and disassemble the oil pump.

Screw

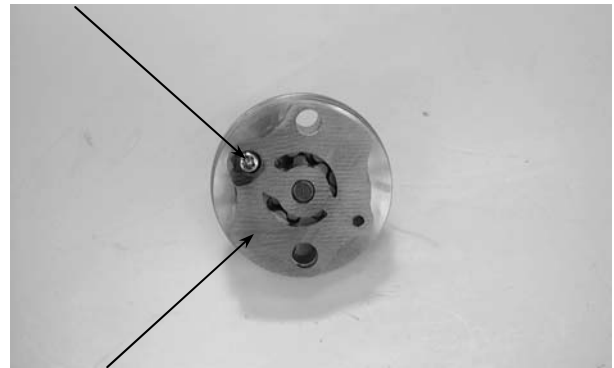

Pump Body

INSPECTION

Measure the pump body-to-outer rotor clearance.

Service Limit: 0.12mm

Outer Rotor

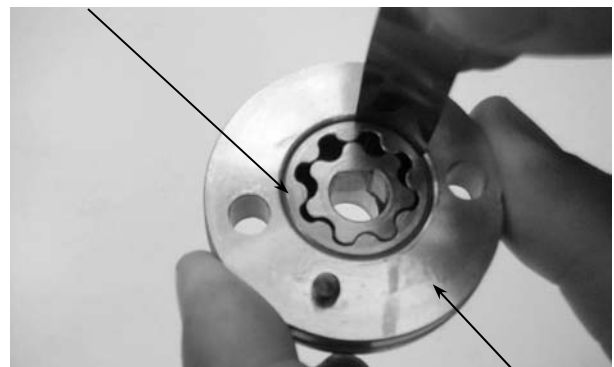

Pump Body

Measure the inner rotor-to-outer rotor clearance.

Service Limit: 0.12mm

Outer Rotor

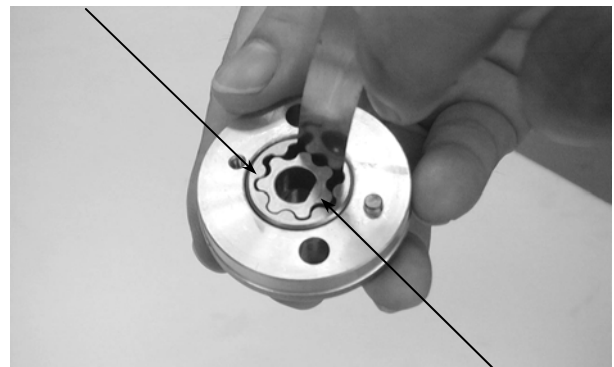

Inner Rotor

Measure the rotor end-to-pump body clearance.

Service Limit: 0.2mm

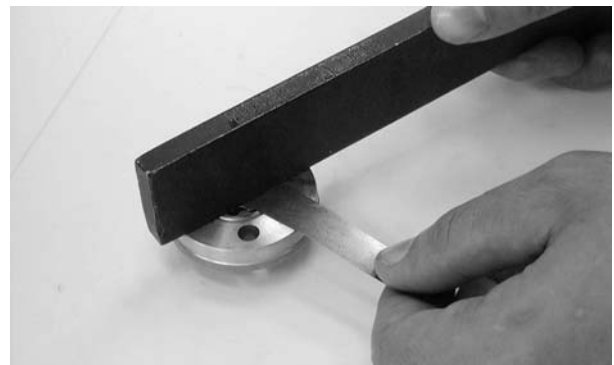

4. LUBRICATION SYSTEM

ASSEMBLY

Install the outer rotor, inner rotor and pump shaft into the pump body.

- * Insert the pump shaft by aligning the flat on the shaft with the flat in the inner rotor.

Install the dowel pin.
Install the pump cover by aligning the hole in the cover with the dowel pin.

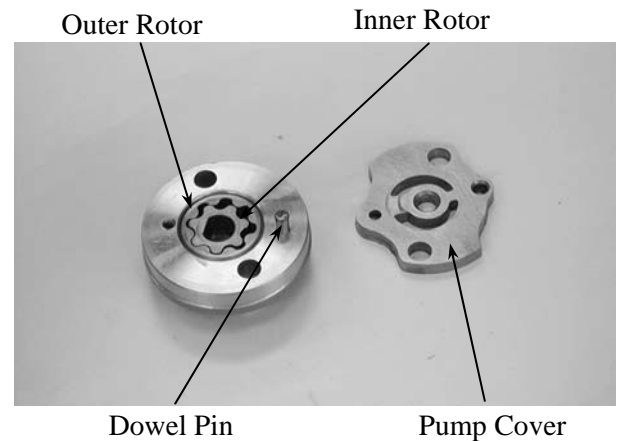

Tighten the screw to secure the pump cover. Make sure that the pump shaft rotates freely without binding.

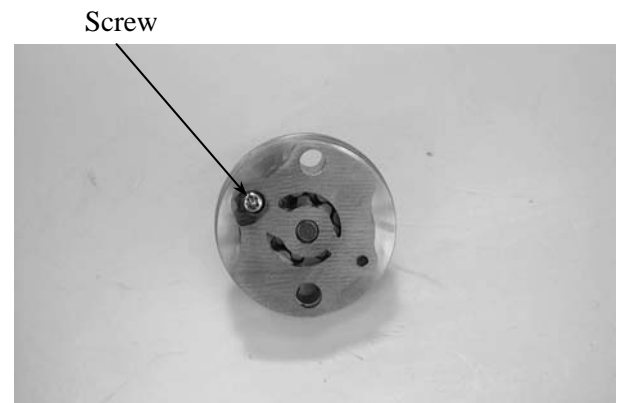

INSTALLATION

Install the oil pump into the crankcase.

- * Install the oil pump with the arrow on the pump body facing up and fill the oil pump with engine oil before installation.

After the oil pump is installed, tighten the two mounting bolts.

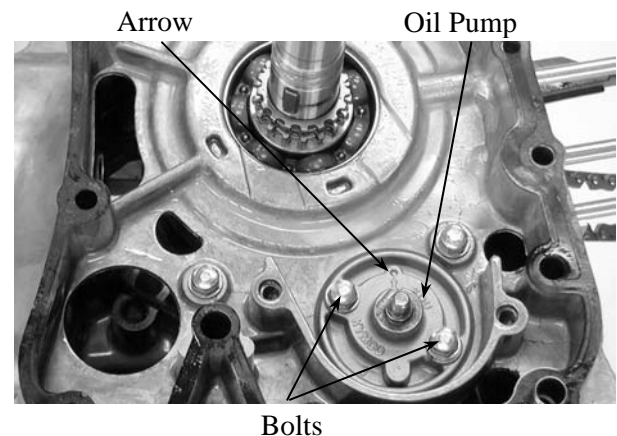

Install the pump driven gear and drive chain by aligning the pump driven gear with the cutout in the pump shaft.
Install and tighten the pump driven gear nut.

Torque: 1.0kg-m

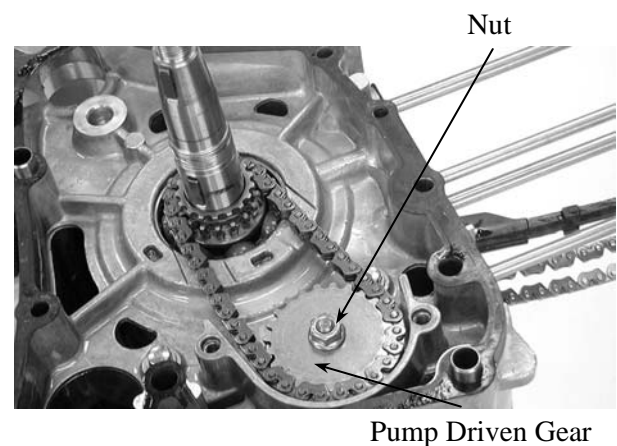

4. LUBRICATION SYSTEM

Install the oil separator cover and tighten the bolts.

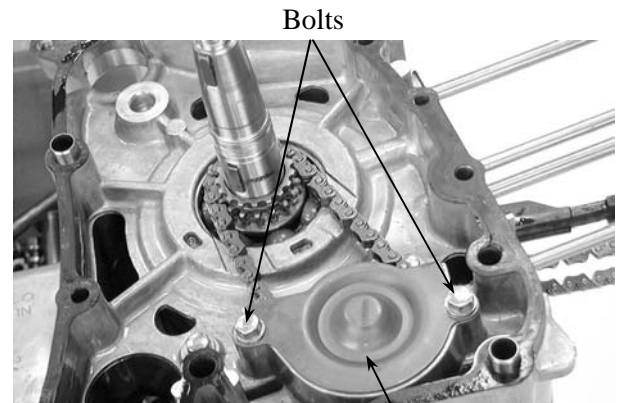

Oil Separator Cover

Install the starter idle gear and starter clutch.
Install the gasket and dowel pins.

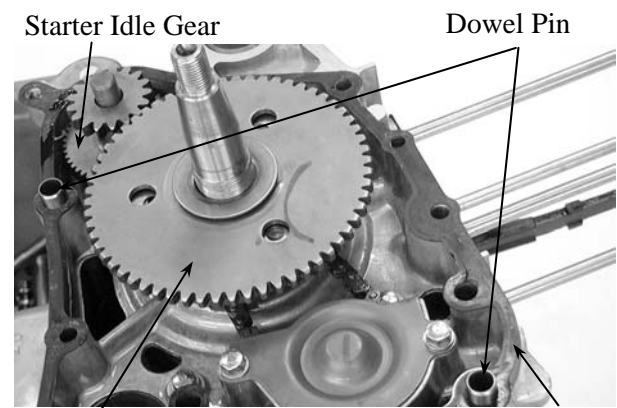

Starter Clutch

Gasket

Install the right crankcase cover and tighten the nine bolts.

Torque: 0.9kg-m

* Diagonally tighten the bolts in 2~3 times.

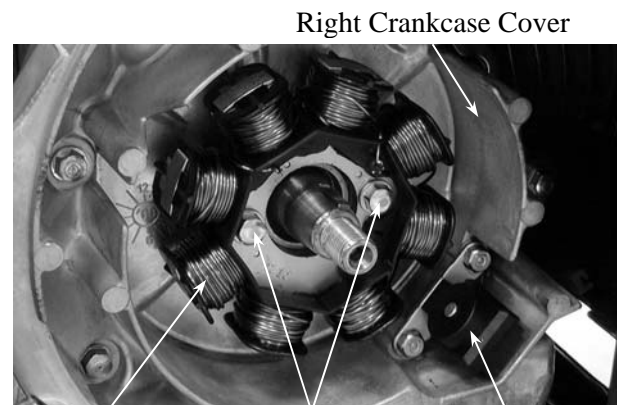

Stator

Bolts

Pulser Coil

5. FUEL SYSTEM

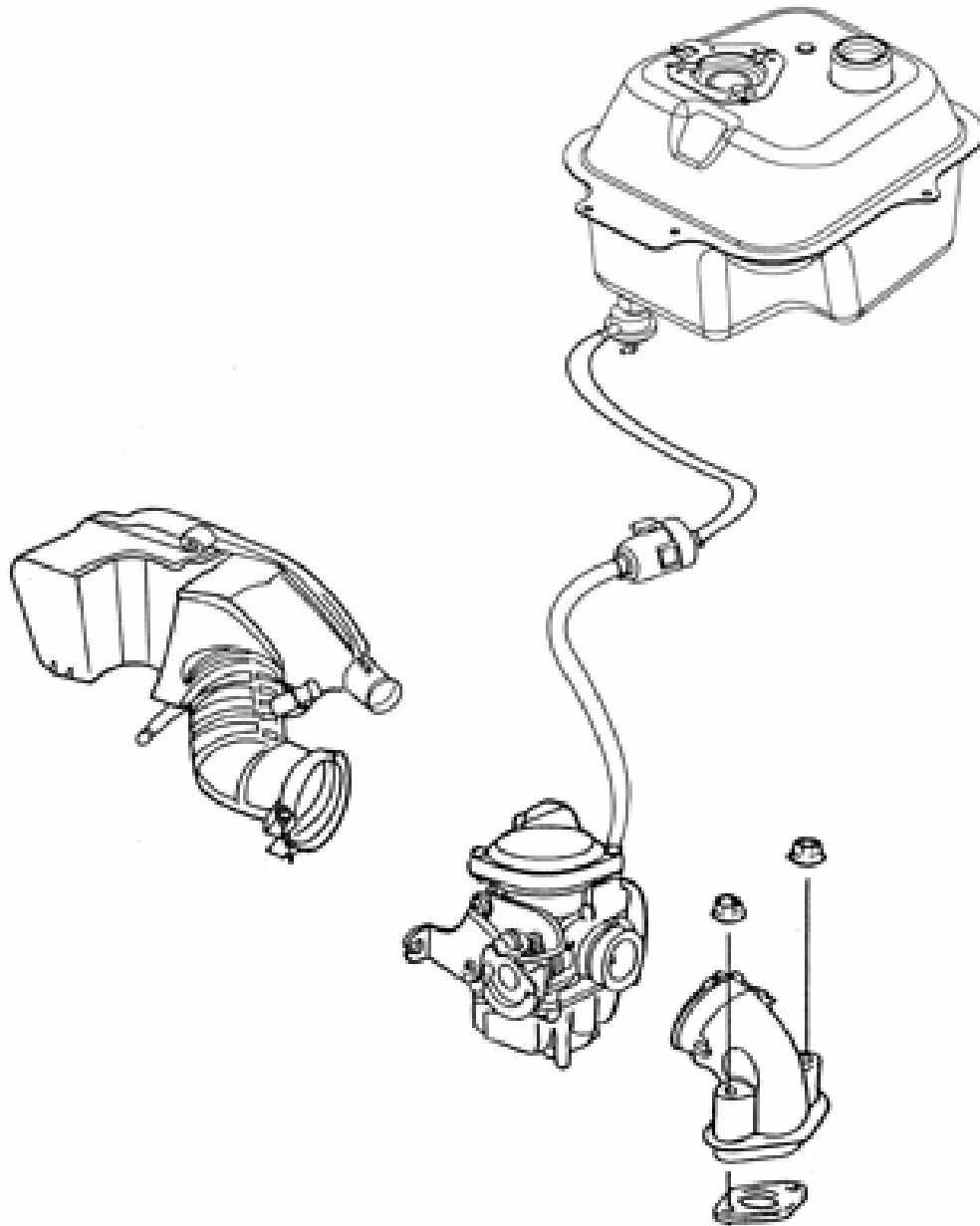

5

5. FUEL SYSTEM

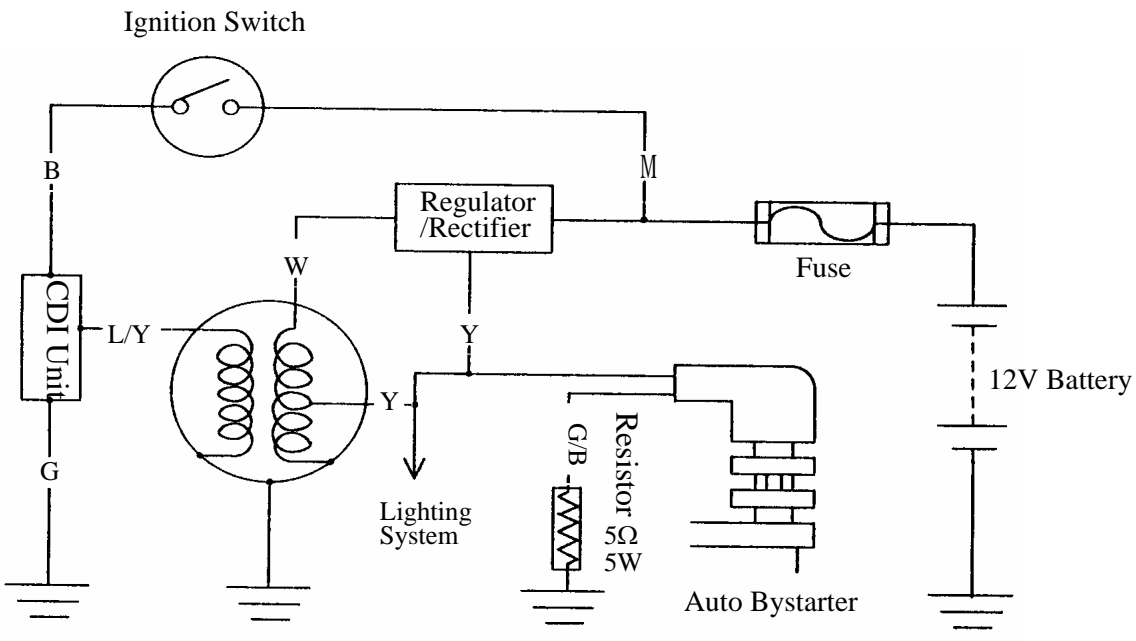
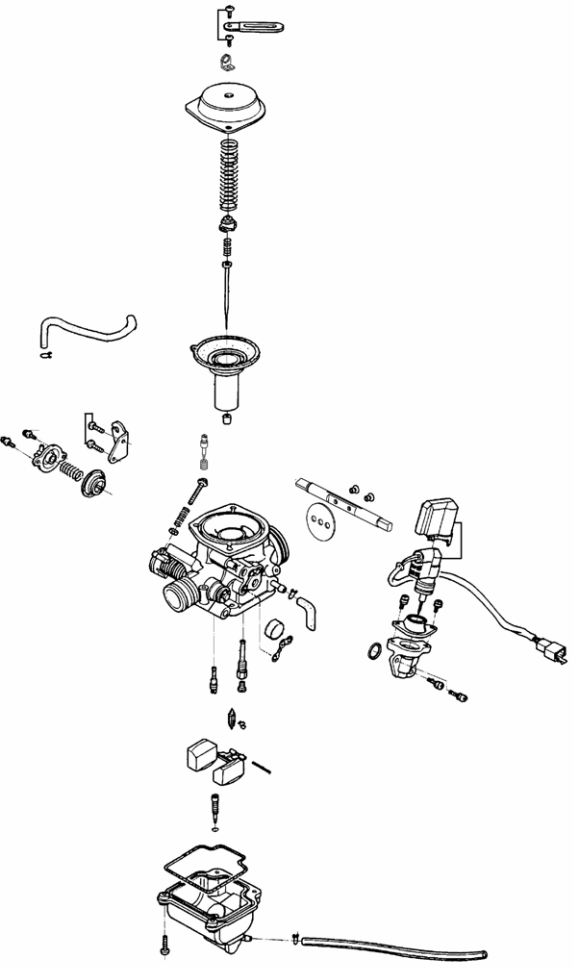

SERVICE INFORMATION.....5-2	CARBURETOR INSTALLATION.....5-10
TROUBLESHOOTING.....5-3	PILOT SCREW ADJUSTMENT5-11
CARBURETOR REMOVAL.....5-4	FUEL TANK.....5-12
AUTO BYSTARTER5-4	FUEL UNIT5-13
AIR CUT-OFF VALVE5-6	AIR CLEANER5-13
VACUUM CHAMBER.....5-6	
FLOAT CHAMBER.....5-8	

SERVICE INFORMATION

GENERAL INSTRUCTIONS



Gasoline is very dangerous. When working with gasoline, keep sparks and flames away from the working area.
Gasoline is extremely flammable and is explosive under certain conditions. Be sure to work in a well-ventilated area.

- When disassembling the carburetor, be sure to service the vacuum piston and float chamber.
- Do not bend or twist control cables. Damaged control cables will not operate smoothly.
- When disassembling fuel system parts, note the locations of O-rings. Replace them with new ones during assembly.
- Before float chamber disassembly, loosen the drain screw to drain the residual gasoline into a clean container.
- After the carburetor is removed, plug the intake manifold side with a clean shop towel to prevent foreign matters from entering.
- Remove the vacuum diaphragm before cleaning the carburetor air and fuel passages with compressed air to avoid damaging the vacuum diaphragm.
- When the motorcycle is not used for over one month, drain the residual gasoline from the float chamber to avoid erratic idling and clogged slow jet due to deteriorated fuel.

SPECIFICATIONS

Item	Standard
Venturi dia. (mm)	φ26
Type	VE
Float level (mm)	17
Main jet	#104
Slow jet	#35
Idle speed	1700rpm ± 100
Throttle grip free play	2~6mm
Pilot screw opening	3±1/2

5. FUEL SYSTEM

TROUBLESHOOTING

Engine is hard to start

- No spark at plug (⇒Section 15)
- Compression too low
- No fuel to carburetor
 - Clogged fuel filter
 - Restricted fuel line
 - Faulty float valve
 - Incorrectly adjusted float level
- Engine flooded with fuel
 - Clogged air cleaner
 - Fuel overflowing
- Intake air leak
- Contaminated fuel
- Faulty auto bystarter
- Clogged idle system or auto bystarter passages

Rich mixture

- Faulty auto bystarter
- Faulty float valve
- Float level too high
- Clogged air jets
- Dirty air cleaner
- Flooded carburetor

Backfiring at deceleration

- Lean mixture in idle system
- Improper air cut-off valve operation

Misfiring during acceleration

- Faulty ignition system
- Lean mixture
- Faulty accelerating pump

Engine idles roughly, stalls or runs poorly

- Clogged fuel system
- Ignition malfunction
- Rich or lean mixture
- Contaminated fuel
- Intake air leak
- Incorrect idle speed
- Incorrectly adjusted pilot screw
- Clogged idle system or auto bystarter passages
- Incorrectly adjusted float level

Lean mixture

- Clogged fuel jets
- Faulty float valve
- Float level too low
- Clogged fuel system
- Intake air leak
- Improper vacuum piston operation
- Improper throttle operation

5. FUEL SYSTEM

CARBURETOR REMOVAL

Remove the frame right side cover. (⇒2-4)
 Disconnect the auto bystarter wire connector.
 Remove the met-in box. (⇒2-3)



Auto Bystarter Wire Auto Bystarter

Loosen the drain screw and drain the fuel from the float chamber.
 Disconnect the fuel tube and vacuum tube at the carburetor.
 Disconnect the TPS coupler and remove the TPS unit

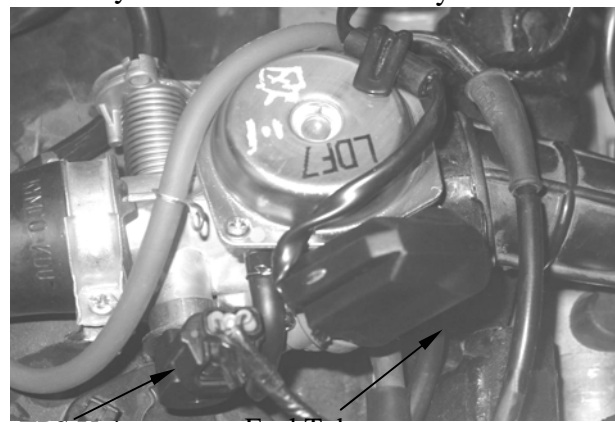

TPS Unit Fuel Tube

Loosen the throttle cable adjusting nut and lock nut, and disconnect the throttle cable from the carburetor.
 Loosen the carburetor intake manifold band and air cleaner connecting tube band screws and then remove the carburetor.

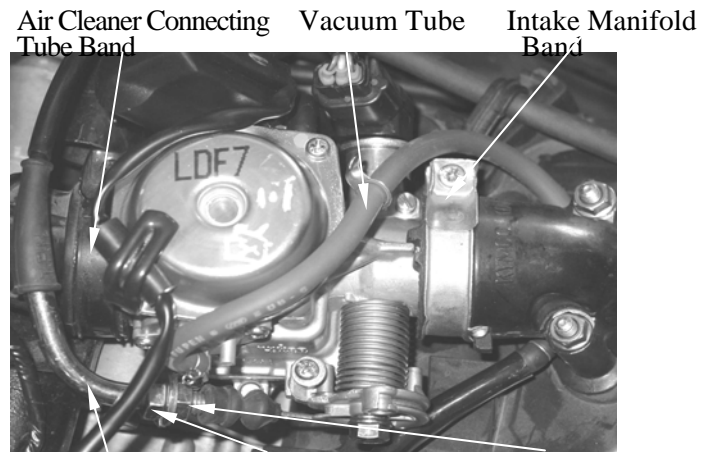

Throttle Cable Adjusting Nut Lock Nut

AUTO BYSTARTER

OPERATION INSPECTION

Measure the resistance between the auto bystarter wire terminals.

Resistance: 10Ω max. (10 minutes minimum after stopping the engine)

If the reading is not within the limit, replace the auto bystarter with a new one.



Connect a hose to the fuel enriching circuit of the carburetor. Connect the auto bystarter yellow wire to the positive (+) terminal of a battery and green wire to the negative (-) terminal. Wait 5 minutes and blow the hose with mouth or vacuum pump. If the passage is blocked, the auto bystarter is normal.

Disconnect the auto bystarter from the battery. Wait 30 minutes and blow the hose with mouth or vacuum pump. If air can be blown into the hose, the auto bystarter is normal.

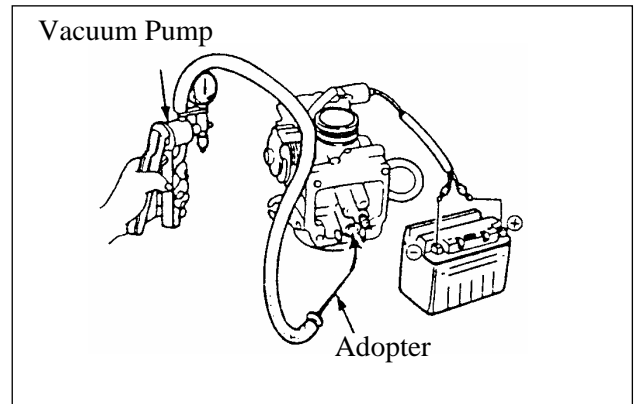

REMOVAL

Remove the set plate screws and set plate. Remove the auto bystarter from the carburetor.

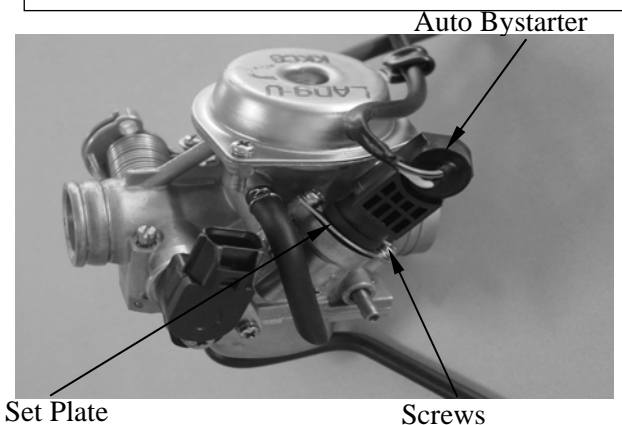

AUTO BYSTARTER INSPECTION

Check the auto bystarter valve and needle for nicks, wear or damage. If any faulty part is found, replace the auto bystarter as a set.

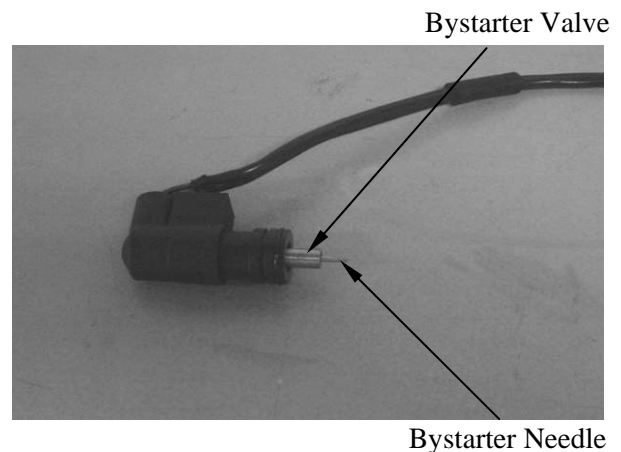

INSTALLATION

Insert the auto bystarter into the carburetor body until it bottoms. Position the set plate into the groove in the auto bystarter and tighten the screws.

- *
- Be sure to install the auto bystarter and set plate properly.
 - Install the set plate with its bottom face facing down.

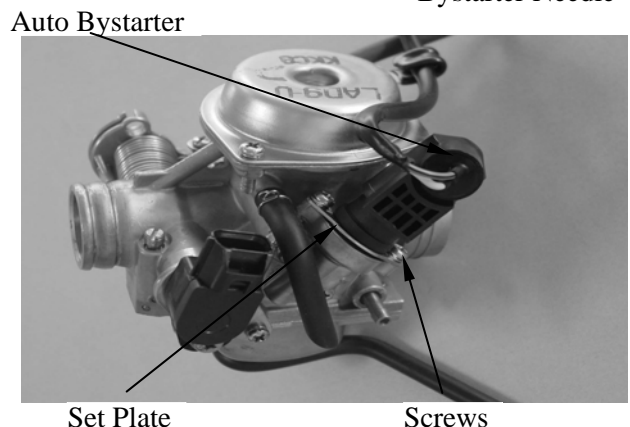

AIR CUT-OFF VALVE

DISASSEMBLY

Remove the two screws attaching the air cut-off valve. Remove the spring and vacuum diaphragm. Check the vacuum diaphragm for cracks or damage and check each passage for clogging.

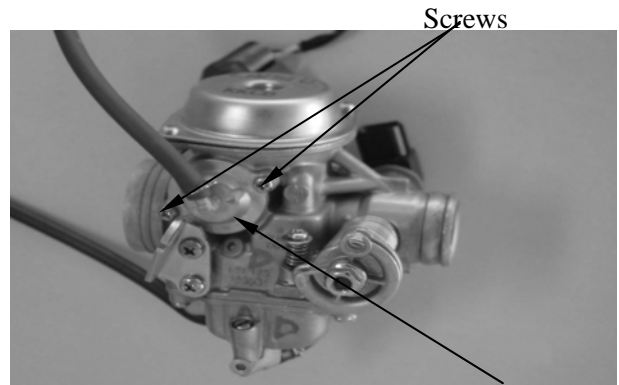

Screws
Air Cut-off Valve Cover

ASSEMBLY

Install the vacuum diaphragm onto the carburetor. Install the spring and air cut-off valve cover. Install the throttle cable set plate and tighten the two screws.

- * • Be sure to set the vacuum diaphragm lip into the groove on the carburetor.
- When installing the air cut-off valve cover, make sure that the vacuum diaphragm is properly installed.

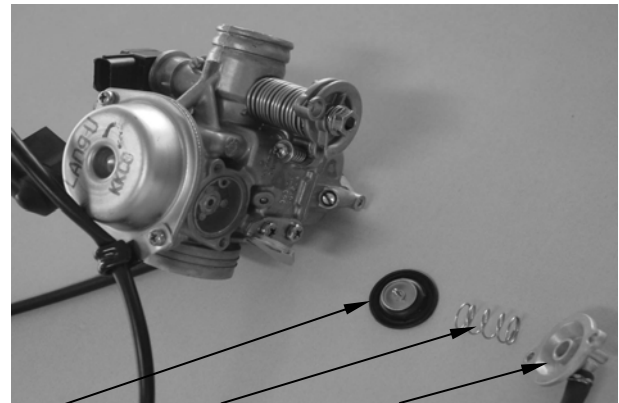

Diaphragm Spring Cover

VACUUM CHAMBER

DISASSEMBLY

Remove the two vacuum chamber cover screws and the cover.

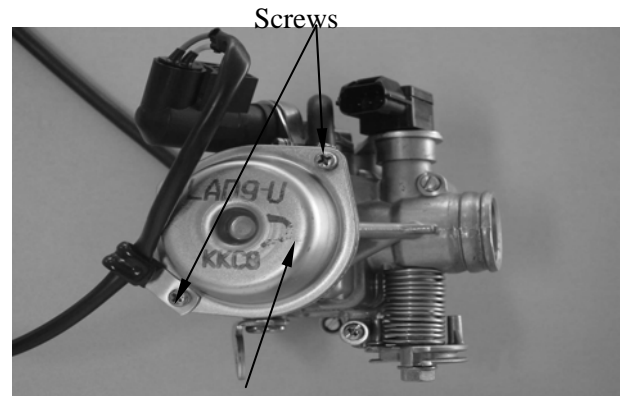

Screws
Vacuum Chamber Cover

Remove the spring and vacuum diaphragm/piston.

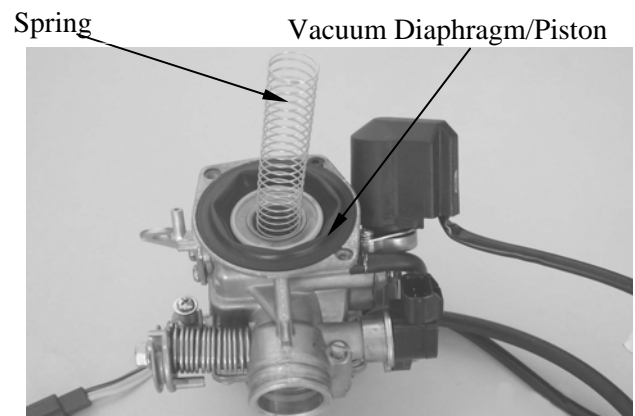

Spring Vacuum Diaphragm/Piston

5. FUEL SYSTEM

Remove the needle holder and jet needle.

* Be careful not to damage the vacuum diaphragm.



INSPECTION

Inspect the needle for stepped wear.
 Inspect the vacuum piston for wear or damage.
 Inspect the diaphragm for deterioration and tears.

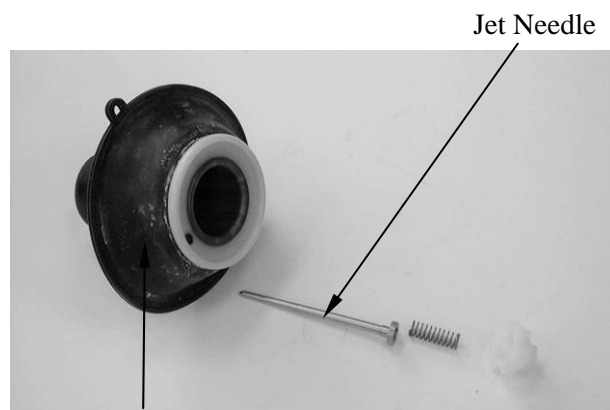

Vacuum Diaphragm

Vacuum Diaphragm

Vacuum Chamber Cover

ASSEMBLY

Install the vacuum piston/diaphragm in the carburetor body.
 Install the spring and then install the vacuum chamber cover.
 Tighten the two screws.

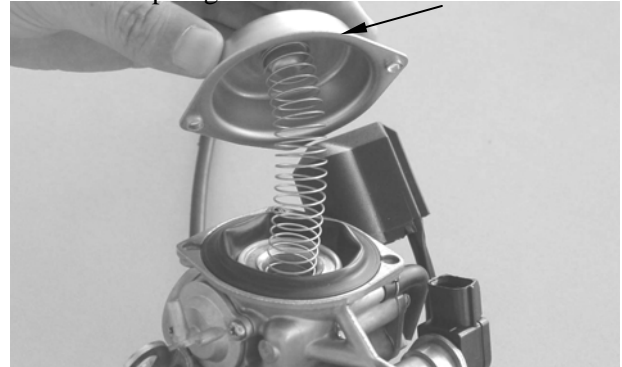

5. FUEL SYSTEM

FLOAT CHAMBER

DISASSEMBLY

Remove the three float chamber screws and the float chamber.

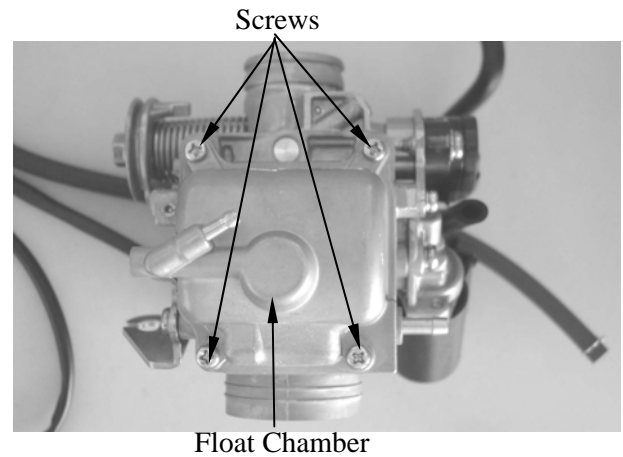

Loosen the float pin screw.
Remove the float pin, float and float valve.

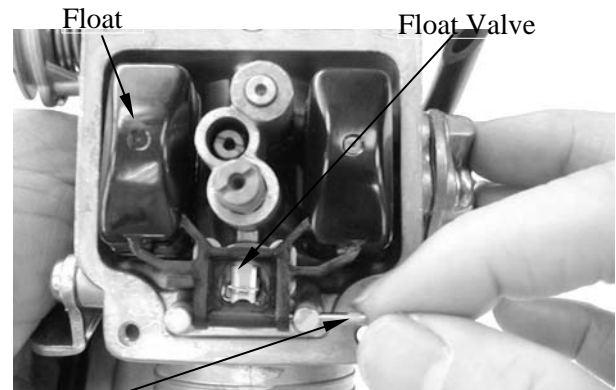

Remove the main jet, needle jet holder, needle jet, slow jet and pilot screw.

- ***
- Be careful not to damage the fuel jets and pilot screw.
 - Before removing, turn the pilot screw in and carefully count the number of turns until it seats lightly and then make a note of this.
 - Do not force the pilot screw against its seat to avoid seat damage.

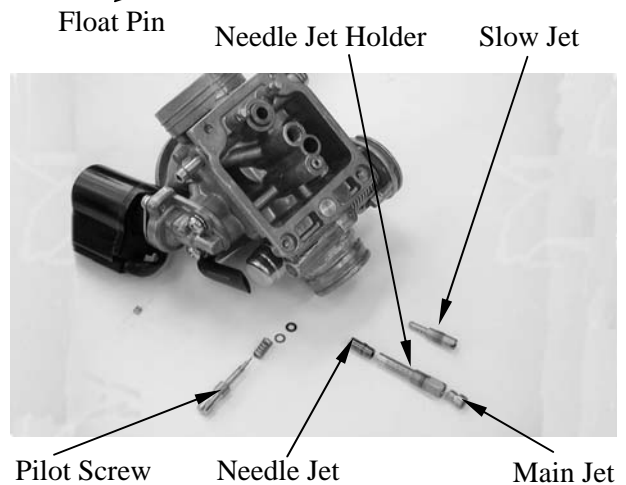

Clean the removed fuel jets with detergent oil and blow them open with compressed air.
Blow compressed air through all passages of the carburetor body.

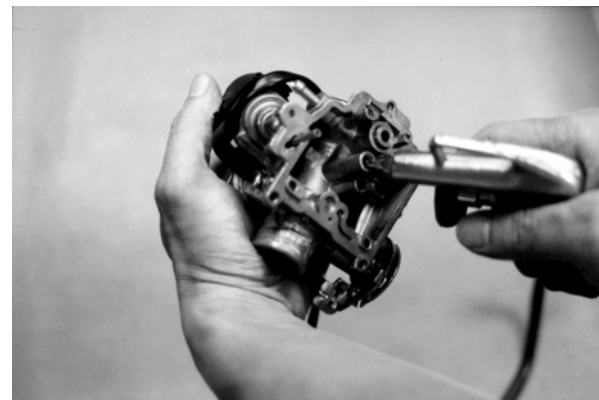

INSPECTION

Inspect the float valve and valve seat for damage or clogging.
Inspect the float valve and valve seat contact area for stepped wear or contamination.

* Worn or contaminated float valve and valve seat must be replaced because it will result in float level too high due to incomplete airtightness.

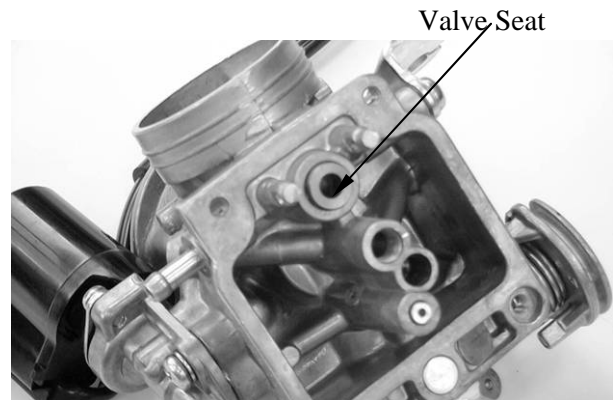

ASSEMBLY

Install the slow jet, needle jet, needle jet holder, main jet and pilot screw.

* Return the pilot screw to the original position as noted during removal.

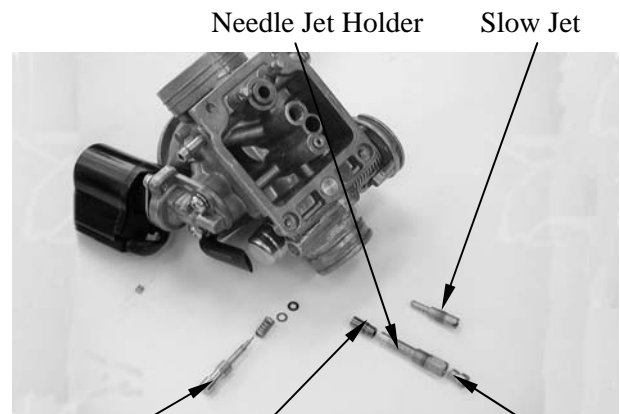

Standard Opening: $3 \pm 1/2$ turns

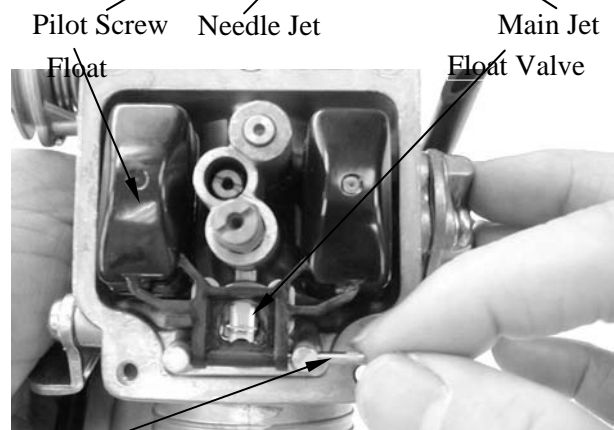

Install the float valve, float and float pin.

FLOAT LEVEL INSPECTION

* • Check the operation of the float valve and float before this inspection.
• Measure the float level by placing the float level gauge on the float chamber face parallel with the main jet.

Measure the float level.

Float Level: 17.0mm

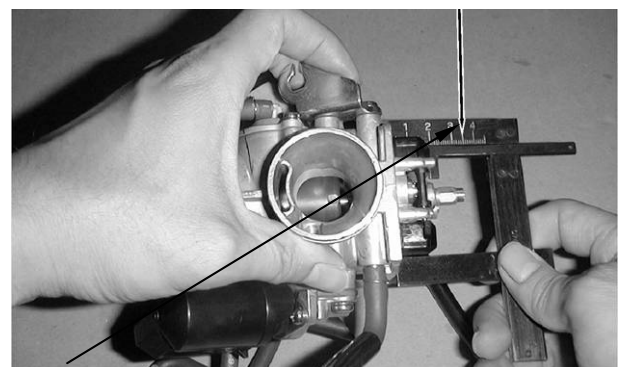

This installation sequence is the reverse of removal.

CARBURETOR INSTALLATION

Tighten the drain screw.
 Install the carburetor onto the intake manifold, aligning the tab on the carburetor with the cutout in the intake manifold.
 Tighten the intake manifold band screw.
 Install the air cleaner connecting tube and tighten the band screw.
 Connect the throttle cable to the throttle wheel on the carburetor.
 Tighten the lock nut.

Air Cleaner Connecting Tube Band Vacuum Tube Intake Manifold Band



Throttle Cable Adjusting Nut Lock Nut

Connect the fuel tube and vacuum tube to the carburetor.

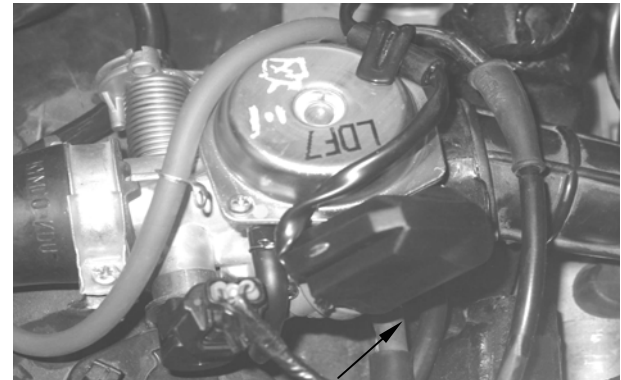

Fuel Tube

Connect the auto bystarter wire connector.
 Perform the following inspections and adjustments:

- Throttle grip free play (⇒3-3)
- Carburetor idle speed (⇒3-5)

Connect the auto TPS unit wire connector.

TPS Nut



Auto Bystarter Wire Connector

PILOT SCREW ADJUSTMENT

* ADJUSTMENT

- *
 - The pilot screw is factory pre-set and no adjustment is necessary. During carburetor disassembly, note the number of turns of the pilot screw and use as a reference when reinstalling it.
 - Place the motorcycle on its main stand on level ground for this operation.



Pilot Screw

A tachometer must be used when adjusting the engine speed. Turn the pilot screw clockwise until it seats lightly and back it out to the specification given.

Standard Opening: $3 \pm 1/2$ turns

- *
 - The carburetor must be adjusted when the engine is warm and the auto bystarter is closed.
 - Do not force the pilot screw against its seat to prevent damage.

Warm up the engine and adjust the throttle stop screw to obtain the specified idle speed.

Idle Speed: 1700 ± 100 rpm

Turn the pilot screw in or out slowly to obtain the highest engine speed. Slightly accelerate several times to make sure that the idle speed is within the specified range. If the engine misses or runs erratic, repeat the above steps.

Throttle Stop Screw

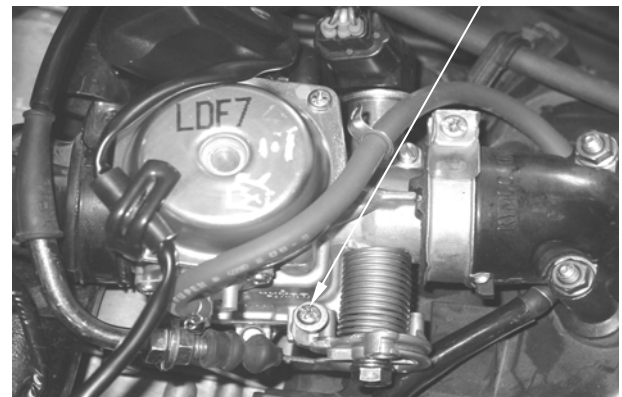

5. FUEL SYSTEM

FUEL TANK REMOVE

Remove the net-in box. (⇒2-3)
 Remove the frame center cover.
 Remove the frame body cover. (⇒2-3)
 Remove the four bolts on the fuel tank, take the upper seat lock off.
 Disconnect the fuel unit wire connector.
 Remove the fuel tank.
 The installation sequence is the reverse of removal.

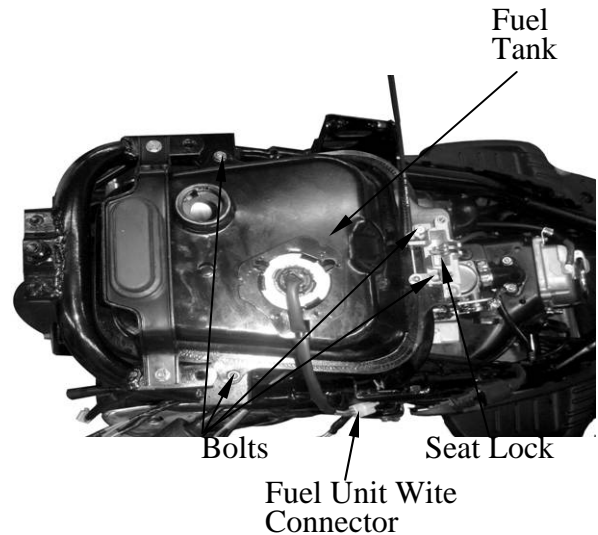

FUEL STRAINER REMOVAL

Remove the fuel strainer from the fuel tank.

INSPECTION

Inspect if the fuel strainer is clogged and clean it with compressed air.

- *
 • When removing the fuel strainer, do not allow flames or sparks near the working area and drain the residual gasoline into a container.



INSTALLATION

Install the fuel strainer with its arrow mark toward the fuel pump.

Fuel Strainer

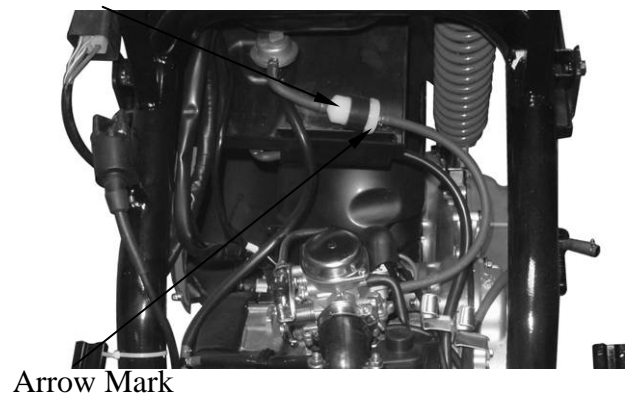

Arrow Mark

5. FUEL SYSTEM

FUEL UNIT

REMOVAL

Remove the related parts.
 Disconnect the fuel unit wire connector.
 Turn the fixed plate on the fuel unit, take the fuel unit off.

- * Do not bend the float arm on the fuel unit, otherwise the figure on the fuel meter will not correct.

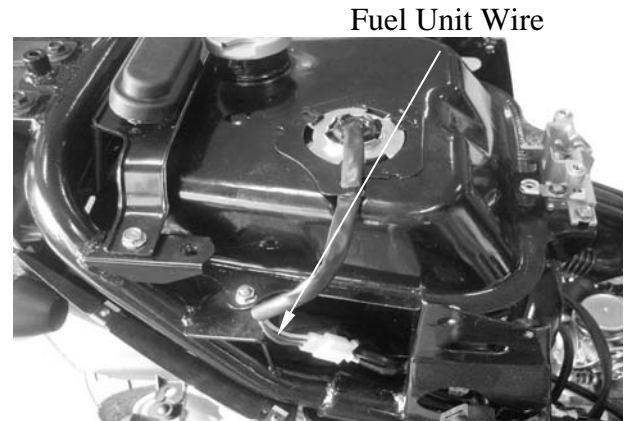

INSTALLATION

Inspect if the fuel unit is damaged, or hardened.
 Assemble the fuel unit in the reverse order of disassembly.

- *
 - Align the groove on the fuel unit with the angle on the fuel tank.
 - Inspect if the fuel tank leaked after installing and filling the gasoling.

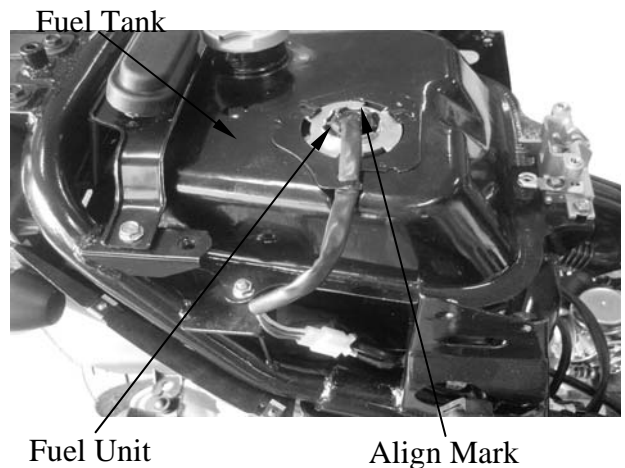

AIR CLEANER

Loosen the air cleaner connecting tube band screw.
 Disconnect the clinhead cover breather tube from the air cleaner.
 Remove the two bolts and air cleaner case.

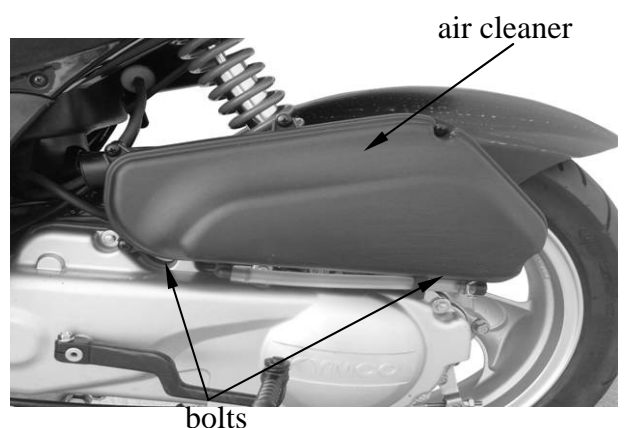

5. FUEL SYSTEM

TPS REMOVE

Remove the TPS stay screw.
Remove the TPS and TPS stay assembled.

- * While clean the carburetor, must remove the TPS unit.

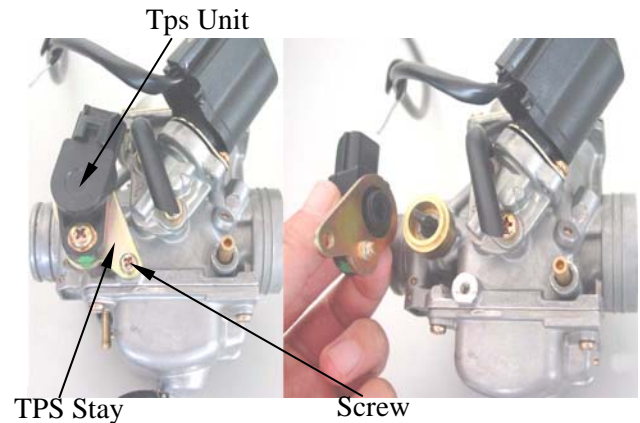

TPS UNIT INSPECTION

Measure the TPS resistance between the violet/black and green wire terminals.

Measure the resistance: $5K\Omega \pm 30\%$

Measure the TPS resistance between the violet/red and green wire terminals.

Measure the resistance: $5K\Omega \pm 30\%$

- * When measure the TPS resistance, carburetor throttle open the max place .

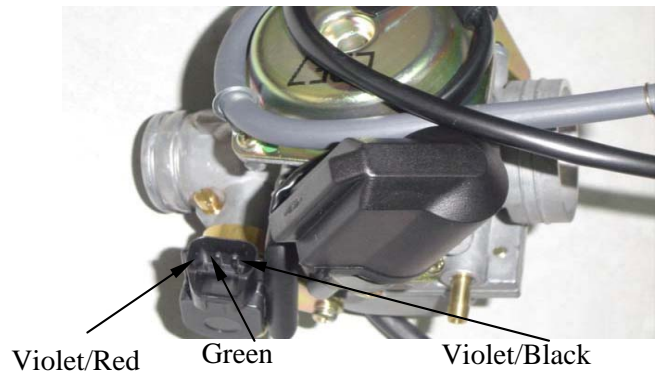

The installation sequence is the reverse of removal.

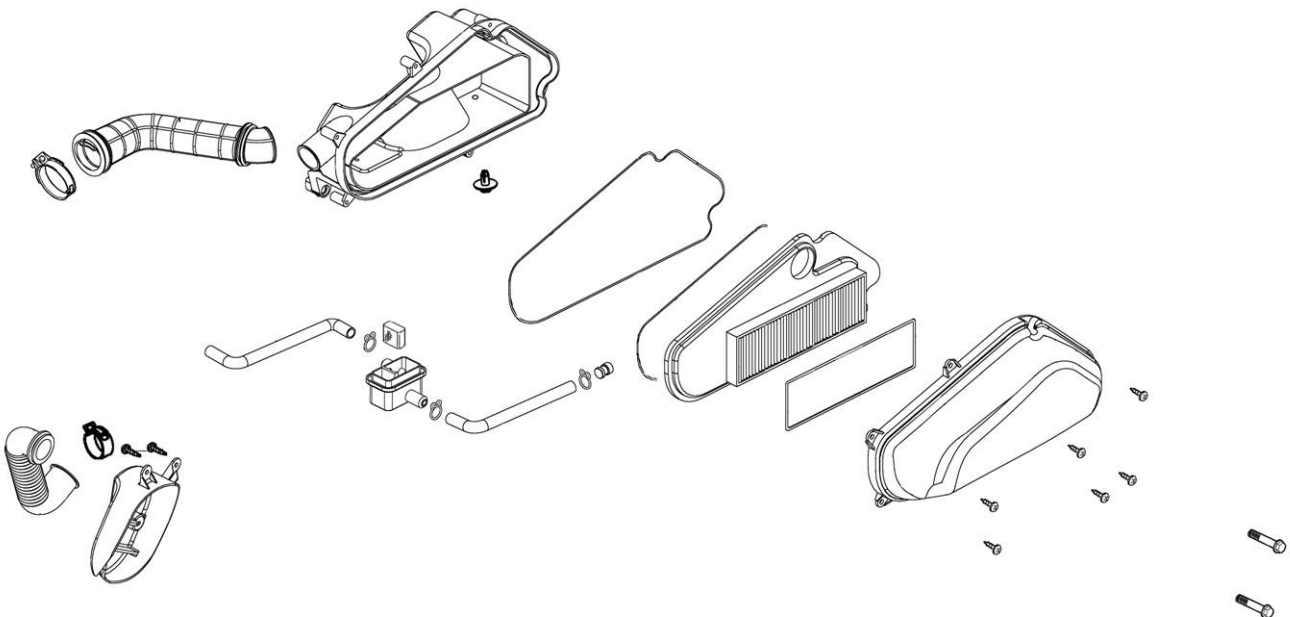

6. ENGINE REMOVAL/INSTALLATION

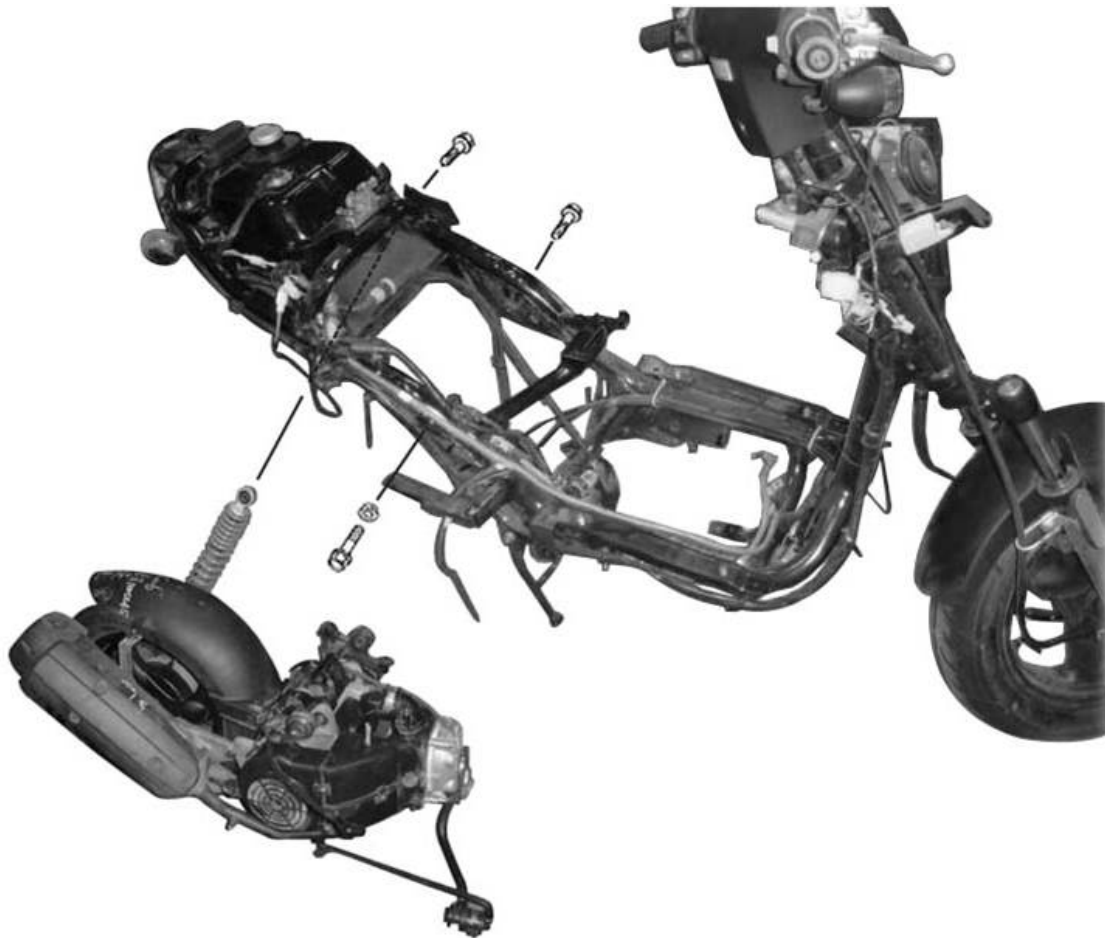

6

6. ENGINE REMOVAL/INSTALLATION

SERVICE INFORMATION	6-1	ENGINE INSTALLATION	6-4
ENGINE REMOVAL	6-2		

SERVICE INFORMATION

GENERAL INSTRUCTIONS

- A floor jack or other adjustable support is required to support and maneuver the engine. Be careful not to damage the motorcycle body, cables and wires during engine removal.
- Use shop towels to protect the motorcycle body during engine removal.
- Parts requiring engine removal for servicing:
 - Crankcase
 - Crankshaft

6. ENGINE REMOVAL/INSTALLATION

ENGINE REMOVAL

Disconnect the battery negative cable.
Remove the frame body cover.
Disconnect the engine negative cable.
Disconnect the spark plug high tension wire.
Disconnect the auto bystarter wire connector.



Auto Bystarter Wire Connector

Disconnect the starter motor cable from the starter relay.
Remove the spark plug cap and disconnect the ignition coil wire from the set plate.

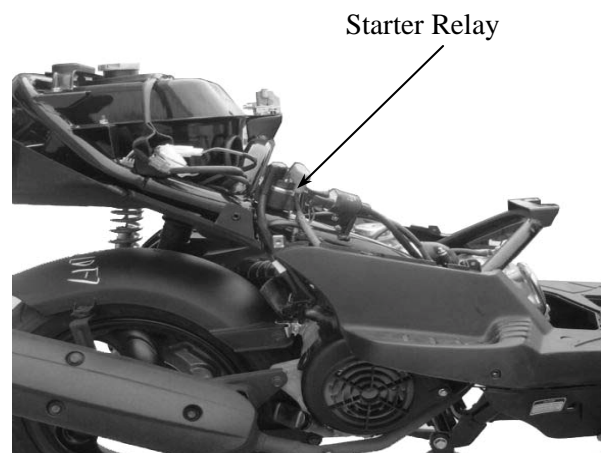

Starter Relay

Vacuum Tube

Fuel Tube

Disconnect the fuel tube and vacuum tube that go to the carburetor from the fuel pump.
Disconnect the vacuum tube from the air cut-off valve.
Disconnect the throttle cable from the carburetor.



Tee Tube

Connecting Tube

Loosen the drive belt air cleaner connecting tube band screw and remove the connecting tube.

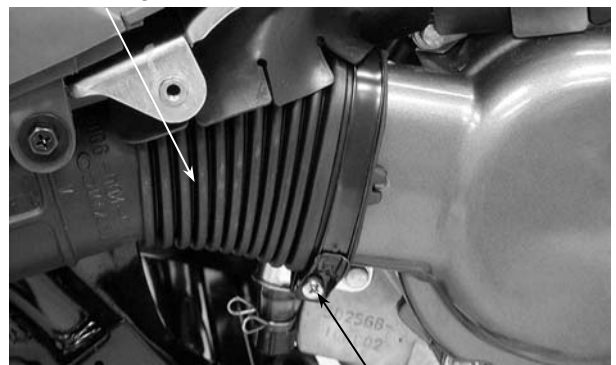

Screw

6. ENGINE REMOVAL/INSTALLATION

Remove the air cleaner bolts.
Remove the rear brake adjusting nut,
connecting pin and rear brake cable.

Brake Adjusting Nut

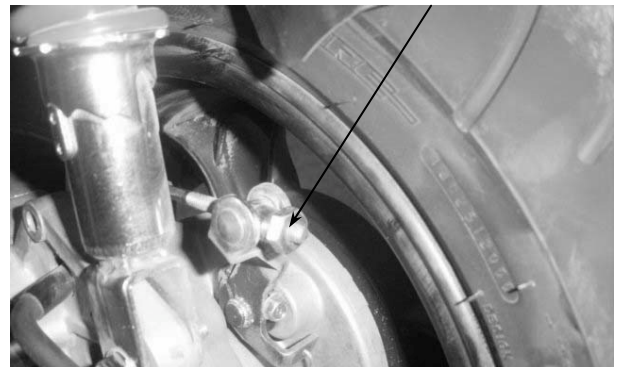

Remove the rear shock absorber lower
mount bolt.

Rear Shock Absorber Lower Mount Bolt

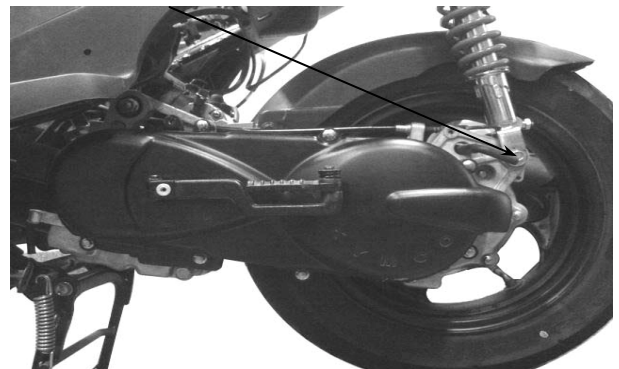

Remove the four A.C. generator cooling fan
cover bolts and cooling fan cover.
Remove the engine mounting bolt and pull
out the engine with the engine hanger
bracket backward.

Engine Mounting Bolt

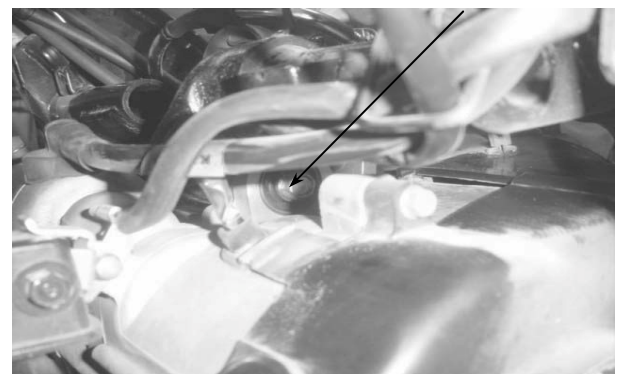

ENGINE HANGER BRACKET REMOVAL

Remove the ignition coil from the engine
hanger.
Remove the engine hanger bracket bolt and
nut.
Remove the engine hanger bracket.

Engine Hanger Bracket

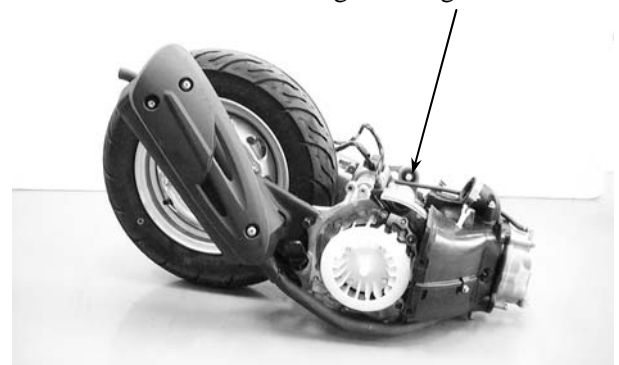

6. ENGINE REMOVAL/INSTALLATION

Inspect the engine hanger bushings and stopper rubbers for wear or damage.

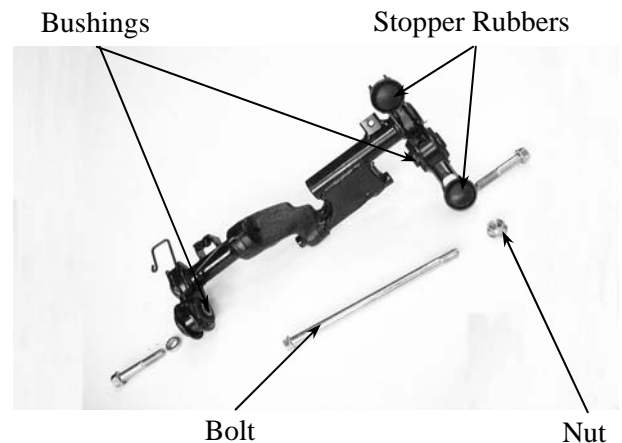

ENGINE HANGER BRACKET INSTALLATION

Install the engine hanger bracket to the engine.
Install the engine hanger bracket bolt and tighten the nut.

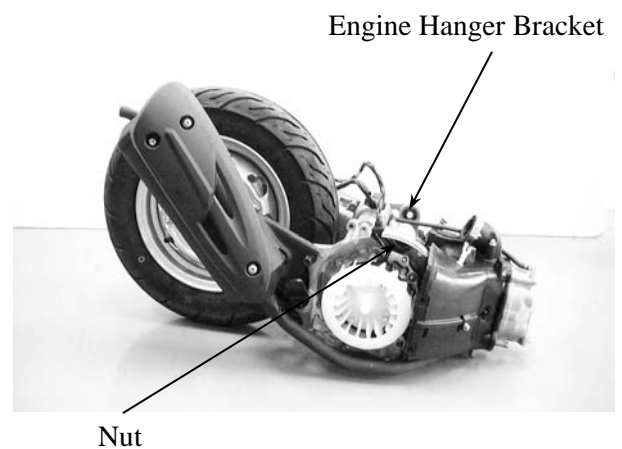

ENGINE INSTALLATION

Install the engine and tighten the engine mounting bolt.

Torque: 7.0kg-m

Tighten the rear shock absorber upper mount bolt.

Torque: 4.0kg-m

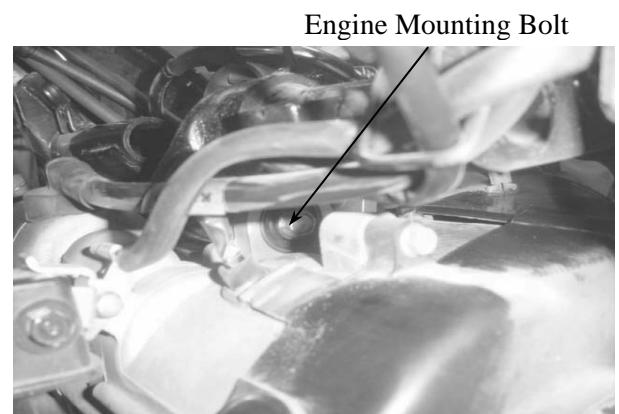

Install the removed parts in the reverse order of removal.

* Route the wires and cables properly.

After installation, inspect and adjust the following:

- Throttle grip free play.
- Rear brake adjustment.

Rear Shock Absorber Lower Mount Bolt

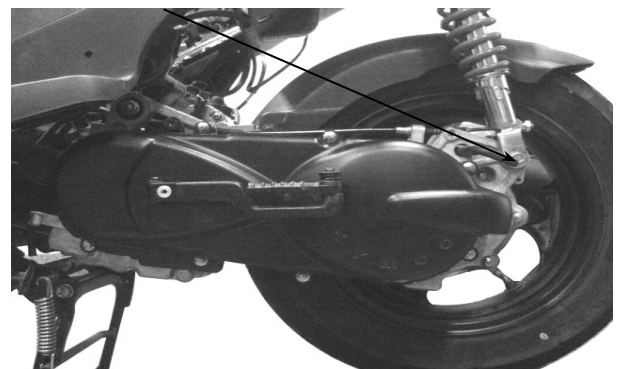

7. CYLINDER HEAD/VALVES

7

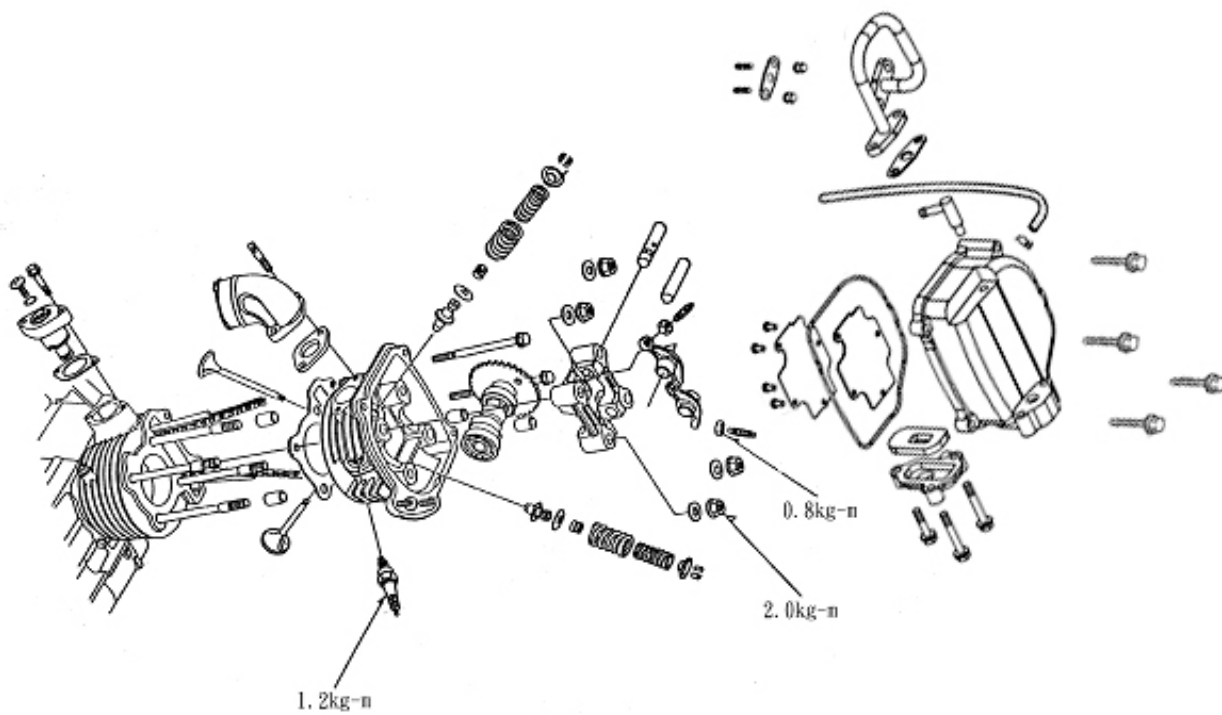

7. CYLINDER HEAD/VALVES

SERVICE INFORMATION.....	7-1	CYLINDER HEAD DISASSEMBLY	7-7
TROUBLESHOOTING	7-2	CYLINDER HEAD ASSEMBLY	7-8
CAMSHAFT REMOVAL.....	7-3	CYLINDER HEAD INSTALLATION	7-8
CYLINDER HEAD REMOVAL	7-5	CAMSHAFT INSTALLATION.....	7-9

SERVICE INFORMATION

GENERAL INSTRUCTIONS

- The cylinder head can be serviced with the engine installed in the frame.
- When assembling, apply molybdenum disulfide grease or engine oil to the valve guide movable parts, valve arm and camshaft sliding surfaces for initial lubrication.
- The camshaft is lubricated by engine oil through the cylinder head engine oil passages. Clean and unclog the oil passages before assembling the cylinder head.
- After disassembly, clean the removed parts and dry them with compressed air before inspection.
- After removal, mark and arrange the removed parts in order. When assembling, install them in the reverse order of removal.

SPECIFICATIONS

Item		Standard (mm)	Service Limit (mm)
Valve clearance (cold)	IN	0.12	—
	EX	0.12	—
Cylinder head compression pressure		13kg/cm ²	
Cylinder head warpage		—	
Camshaft cam height	IN	29.803	29.40
	EX	29.5637	29.16
Valve rocker arm I.D.	IN	10.000~10.015	10.10
	EX	10.000~10.015	10.10
Valve rocker arm shaft O.D.	IN	9.972~9.987	9.91
	EX	9.972~9.987	9.91
Valve seat width	IN	1.0	1.8
	EX	1.0	1.8
Valve stem O.D.	IN	4.975~4.990	4.90
	EX	4.955~4.970	4.90
Valve guide I.D.	IN	5.000~5.012	5.03
	EX	5.000~5.012	5.03
Valve stem-to-guide clearance	IN	0.010~0.037	0.08
	EX	0.030~0.057	0.10

7. CYLINDER HEAD/VALVES

TORQUE VALUES

Cylinder head nut	2.0kg-m	Apply engine oil to threads
Valve clearance adjusting nut	0.9kg-m	Apply engine oil to threads
Stud bolt	0.9~1.1kg-m	

SPECIAL TOOLS

Valve spring compressor

TROUBLESHOOTING

- The poor cylinder head operation can be diagnosed by a compression test or by tracing engine top-end noises.

Poor performance at idle speed

- Compression too low

Compression too low

- Incorrect valve clearance adjustment
- Burned or bend valves
- Incorrect valve timing
- Broken valve spring
- Poor valve and seat contact
- Leaking cylinder head gasket
- Warped or cracked cylinder head
- Poorly installed spark plug

Compression too high

- Excessive carbon build-up in combustion chamber

White smoke from exhaust muffler

- Worn valve stem or valve guide
- Damaged valve stem seal

Abnormal noise

- Incorrect valve clearance adjustment
- Sticking valve or broken valve spring
- Damaged or worn camshaft
- Worn cam chain guide
- Worn camshaft and rocker arm